

ECBC

Energy
Conservation
Building
Code 2017



GOVERNMENT OF INDIA
MINISTRY OF POWER



Bureau of Energy Efficiency
Ministry of Power, Government of India



BEE Copy - Not For Circulation

ENERGY
CONSERVATION
BUILDING
CODE
2017

BEE Copy - Not for Circulation



BEE Copy - Not For Circulation

Energy Conservation Building Code

© 2017 Bureau of Energy Efficiency

Published by
Bureau of Energy Efficiency
4th Floor, Sewa Bhawan, R K Puram, New Delhi, India

No portion (graphics or text) of this Code may be reproduced, translated, or transmitted in any form or manner by any means – including but not limited to electronic copy, photocopy, or any other information storage and retrieval system without explicit written consent from Bureau of Energy Efficiency, New Delhi.

All rights reserved
Printed in New Delhi, India
ISBN No. – XXXXXXXX

1st Printed: June 2017

Printed on FSC® Certified 100% recycled material with non-petroleum, vegetable based inks

FSC® C084365-COC- 003187

BEE Copy - Not For Circulation

पीयूष गोयल
PIYUSH GOYAL



विद्युत, कोयला, नवीन और नवीकरणीय ऊर्जा एवं खान
राज्य मंत्री (स्वतंत्र प्रभार)
भारत सरकार
Minister of State (Independent Charge)
for Power, Coal, New & Renewable Energy and Mines
Government of India



Message

Indian economy has expanded aggressively in the last few decades and it is poised for greater growth in the future. However, our progress is accompanied with unique local and global challenges. Rapid economic growth, urbanization and expanding population have imposed a great strain on energy supply resources. Our economic development policies and international commitments to climate change mitigation are centred on the twin targets of spurring rapid market growth with minimal environmental impact.

India has committed to reduce emissions intensity of the national GDP by 33% to 35% by 2030 from 2005 level. Transformation of the building sector to the most advanced standards of building energy efficiency like near zero energy buildings is crucial for achieving these targets. Buildings consume about one third of the total annual electrical energy consumption in the country and are one of the largest contributors to GHG emissions. With nearly 70% of the buildings required in 2030 yet to be built, this sector will continue to impact any efforts to contain GHG emissions.

Energy Conservation Building Code (ECBC) 2017 is a powerful regulation to encourage the transition of buildings to efficient use of energy. It is one of the first building energy codes to set provisions for achieving energy neutrality in buildings.

ECBC can be leveraged with government initiatives to encourage environmental sustainability through energy efficiency and renewable energy in buildings. The Government of India's Smart Cities Mission is focused on sustainable urban infrastructure development. Energy efficient buildings is one of the metrics recommended for Smart Cities and ECBC will provide a regulatory framework for accomplishing building energy efficiency as a part of the Mission.

Regulations can only achieve so much; our response must be market based to be self-sustaining in the long term. Enforcement of ECBC can transform markets towards more efficient building materials and technologies by creating a demand for them. India is the founding member of the International Solar Alliance. Provision for renewable energy systems in buildings is one of the requirements of ECBC 2017. This offers a great opportunity to create a demand for solar energy technologies and support the objectives of the International Solar Alliance.

We have witnessed substantial progress in adoption of ECBC across all states since its launch. I congratulate the Bureau of Energy Efficiency (BEE) and state governments in the progress achieved so far. I now urge all states and BEE to continue their aggressive pursuit of energy efficiency in buildings through the code.

Piyush Goyal

Shram Shakti Bhawan, New Delhi-110 001 Phone : +91-11-23717474, 23710411, Fax : +91-11-23710065
E-mail : piyush.goyal@nic.in, Website : www.piyushgoyal.in

प्रदीप कुमार पुजारी
सचिव
भारत सरकार
P. K. PUJARI
Secretary
Government of India



विद्युत मंत्रालय
श्रम शक्ति भवन
नई दिल्ली-110001
Tele : 23710271/23711316
Fax : 23721487
E-mail : secy-power@nic.in
29 March, 2017



Message

India's Nationally Determined Contributions commit to reducing emissions intensity of its GDP to 35% below 2005 levels by 2030. Any effort to achieve this target is contingent upon the increases in efficiency of energy use across all sectors, especially in the building sector.

The building sector in India consumes over 30% of the total electricity consumed in the country annually and is second only to the industrial sector as the largest emitter of greenhouse gases. Energy demand is expected to grow aggressively in the coming years with rising population and technology intensive lifestyles.

Building energy codes have been adopted as a regulatory measure for ushering energy efficiency in the building sector by many countries. In India, the Energy Conservation Act, 2001 provides the basic framework for regulating all initiatives relating to the efficient use of energy and this includes building energy codes.

India's Energy Conservation Building Code (ECBC) was first launched in 2007 as a voluntary code by the Bureau of Energy Efficiency to fulfil its mandate of effecting energy efficiency in buildings under the Energy Conservation Act of 2001.

Updating the ECBC was a priority of the government under the 12th five-year plan. The technical update of ECBC 2007 has been carried out to reflect advancements in energy efficient building technologies and building management practices as well as to streamline the compliance processes.

I am confident that the updated ECBC will establish new benchmarks for energy efficient buildings in the country. I urge all stakeholders in the building industry to support effective implementation of ECBC 2017.

(P. K. Pujari)



बी.पी.पाण्डेय
विशेष सचिव
भारत सरकार
B.P. Pandey
Special Secretary
Government of India



सत्यमेव जयते
Ministry of Power
Shram Shakti Bhawan
New Delhi - 110001

विद्युत मंत्रालय
श्रम शक्ति भवन
नई दिल्ली-110001
Telefax : 23715378/23731442
E-mail : as_power@nic.in

30 March, 2017



Buildings Energy Codes stipulate the minimum energy performance levels for buildings. These codes are updated for enhancing minimum energy conservation standards and also to keep pace with the technological developments. India's Energy Conservation Building Code (ECBC) was originally launched in 2007. Subsequently, with the amendment in Energy Conservation Act, the threshold for applicability of ECBC in buildings has been brought down. Accordingly, ECBC has been updated to expand its scope, incorporate technological advancements and to respond to the changed market scenario.

This updation has been guided keeping in view the ease of implementation for enforcement officials and ease of understanding for building designers. ECBC 2017 is designed to leverage existing knowledge of building designers. Methods for demonstrating compliance with complex code requirements have been added to the code.

The Bureau of Energy Efficiency (BEE) mapped ECBC implementation systems across different states that have adopted the code. In most states, enforcement authorities for bye-law compliance are also responsible for code compliance. BEE has sought to enable greater understanding of the code and its requirements by enforcement officials by synchronizing the Code with model building bye-laws, National Building Code, and other relevant mandatory guidelines for buildings established by Government of India.

I hope that ECBC 2017 will be instrumental in swifter adoption of energy efficient practices in buildings in the country.

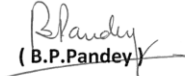
(B.P.Pandey)

Raj Pal
आर्थिक सलाहकार
Economic Adviser
Tel. No.:011-23715595
E-mail : raj.pal@nic.in



भारत सरकार
GOVERNMENT OF INDIA
विद्युत मंत्रालय
MINISTRY OF POWER
श्रम शक्ति भवन, रफी मार्ग
SHRAM SHAKTI BHAWAN, RAFI MARG

नई दिल्ली - 110001
NEW DELHI - 110001

30th March, 2017



MESSAGE

The Government of India announced the Energy Conservation Building Code (ECBC) for new commercial buildings in May 2007. ECBC sets minimum energy standards for new commercial buildings having a connected load of 100 kW or contract demand of 120 kVA and above. While the Central Government has powers under the Energy Conservation Act, 2001 to notify standards of energy consumption in commercial buildings, the state governments can amend the code to suit local or regional needs and notify the same. The major components of the building which are being addressed through the code are: envelope (walls, roofs, windows), lighting systems, HVAC systems, water heating, water pumping and electrical power system.

The enforcement of ECBC lies with the state governments and urban local bodies. A number of states have notified ECBC 2007 with amendments, and several others are in the process of amending the ECBC to suit their local requirements.

In order to facilitate implementation of ECBC, the Bureau of Energy Efficiency (BEE) carried out several enabling measures which, inter alia, included: empanelment of ECBC expert architects, development of technical reference material, development of conformance, compliance check tool, standard training modules, etc.

Keeping in view the advancements in energy efficient building technologies and building management practices and also to streamline the implementation and compliance processes, a need was felt to update the ECBC.

ECBC 2017 is now ready for adoption by the building industry. I hope that all new commercial buildings will not only be ECBC 2017 compliant, but also look to adopting the ECBC+ and Super ECBC standards specified in the new code.

(Raj Pal)





BUREAU OF ENERGY EFFICIENCY
(Ministry of Power, Government of India)



Abhay Bakre

Director General, Bureau of Energy Efficiency

Bureau of Energy Efficiency had launched Energy Conservation Building Code (ECBC) 2007 to establish minimum energy performance standards for buildings in India. Buildings consume significant proportion of our energy resources and the ECBC is an essential regulatory tool to curb their energy footprint.

Building energy codes are updated regularly to catch up with the curve of technology maturation and to set higher benchmarks for building energy efficiency. In alignment with current market scenario and advanced technologies ECBC has been taken for update also. Energy efficient technologies and materials that were aspirational in the years preceding launch of ECBC are now commonly available in Indian markets. Accordingly, ECBC 2017 has been revised to incorporate advanced technologies.

Additional parameters included are related to renewable energy integration, ease of compliance, inclusion of passive building design strategies and, flexibility for the designers. One of the major updates to the code is inclusion of incremental, voluntary energy efficiency performance levels. ECBC 2017 is one of the first building energy codes to recognize beyond code performance. There are now three levels of energy performance standards in the code. In ascending order of efficiency, these are ECBC, ECBCPlus and SuperECBC. The adherence to the minimum requirements stipulated for ECBC level of efficiency would demonstrate compliance with the code. Other two efficiency levels are of voluntary nature. This feature was added to prepare the building industry for meeting energy efficiency standards in coming years and give sufficient time to the market to adapt.

ECBC 2017 is technology neutral. Energy efficiency requirements have been framed to provide architects and engineers artistic and technical freedom as long as minimum efficiency requirements are fulfilled.

Provisions for installation of renewable energy generation systems is mandatory in ECBC 2017. Buildings compliant with the updated code must be ready for installation of renewable energy systems. Proportion of total electricity demand to be met through renewable energy systems increases with the efficiency level the project aspires to.

Passive designs strategies like daylight and shading are mandatory in ECBC 2017. Objective for this change is to encourage design with passive strategies to be the norm for buildings in India. Building energy codes are hinged on climate responsive buildings that use local natural resources and climatic conditions to their advantage.

Passive design strategies are one of the most effective methods to ensure that building designs and technologies are sensitive to the surroundings.

ECBC update process was designed to be a participative exercise that responded to the concerns of the building sector stakeholders while maintaining the technical rigor that must accompany any enforceable building energy code. Numerous meetings and regional workshops were held to develop and review the recommendations. Tremendous participation was seen from practitioners, developers, policy makers and manufacturers during the review workshops conducted in different regions of the country.

On behalf of BEE team, I appreciate the invaluable contributions of the all working group members. Each of them is a luminary of their respective field and have numerous other crucial commitments. Yet for more than three years they worked diligently to ensure that the update process is technically rigorous and the resultant code technically consistent.

The code would not have been completed without the commitment of officials from BEE. Their efforts have ensured that the vision set for code update is embedded in ECBC 2017. I also wish to acknowledge USAID and the team from USAID's Partnership to Advance Clean Energy - Deployment (PACE-D) Technical Assistance program for assisting BEE in anchoring the code update process.

Shri Pradeep Kumar Pujari, Secretary, Ministry of Power; Shri. B P Pandey, Special Secretary, Ministry of Power and Shri Raj Pal, Economic Advisor, Ministry of Power have facilitated the update process and their guidance was instrumental in navigating inter departmental coordination between several Government agencies that oversee building regulations in the country.

I do hope that this endeavour which is evolved through collaborative efforts of many officials will be instrumental in encouraging efficiency in building sector of India. ECBC 2007 laid the foundation for energy efficient buildings in India. ECBC 2017 would aspire to strengthen it further.

Abhay Bakre
Director General
Bureau of Energy Efficiency



BUREAU OF ENERGY EFFICIENCY
(Ministry of Power, Government of India)



Saurabh Diddi

Energy Economist, Bureau of Energy Efficiency

The Energy Conservation Building Code (ECBC) 2017 is now ready for launch. The technical update of the code was required to reflect technological developments that have happened over the intervening period. Also, building management systems have now enabled building energy consumption to be managed and link the same to a number of external and internal operating parameters.

Energy Conservation Building Code 2017 is the culmination of close coordination that started in 2012. This update has been made possible with the commitment and knowledge of Chairs and members of the Working Groups. Dr. N K Bansal, Late Mr. H S Mamak, Dr. R S Agarwal, Dr. Bhim Singh, and Mr. Gulshan Aghi have contributed immensely in developing a comprehensive code. They were joined in the working groups by leading sustainable building experts in India - Mr. G S Modgil, Mr. Sanjay Prakash, Mr. Anurag Bajpai, Dr. Archana Walia, Dr. Milind Rane, Mr. Rajan Rawal, Dr. Jyotirmay Mathur, and Ms. Mili Majumdar.

Energy efficiency measures in ECBC 2017 are informed by actual construction practices and existing level of energy efficiency trends in Indian construction sector. Special thanks are due to members of Refrigeration and Air-Conditioning Manufacturers Association of India, Indian Society of Heating, Refrigerating & Air-conditioning Engineers, Electric Lamp and Component Manufacturers Association of India, International Copper Promotion Council, Indian Electrical and Electronics Manufacturers Association, Central Building Research Institute Roorkee, and Indian Society of Lighting Engineers who shared data on current market trends. Experts from Central Public Works Department, Administrative Staff College of India, Ministry of New and Renewable Energy, Town & Country Planning Organization, Bureau of Indian Standards and other government agencies were instrumental in ensuring that the code is synchronized with other standards and legislation applicable to buildings.

ECBC 2017 also provides for a futuristic building performance standards which the building industry can work towards, irrespective of updates to ECBC. The updated code has defined three levels of energy performance standards. In ascending order of efficiency, these are ECBC compliant building, ECBC+ Building and Super ECBC Building. Fulfilling requirements stipulated for ECBC building level of efficiency is necessary for demonstrating compliance with the code. The other two levels are voluntary. Subsequent updates in ECBC will be focused on making ECBC+ Building and Super ECBC Building the baseline of energy efficient buildings in the country. This feature was added to give notice to the building industry of baseline building energy efficiency standards in coming years and give time to the market to adapt.

The update process was a comprehensive exercise which was able to retain its rigor and technical consistency due to efforts of Ms. Apurva Chaturvedi, Senior Clean Energy Specialist, USAID. Dr. Bhaskar Natarajan from PACE-D TA program provided constant support and guidance in management of the code development processes.

BEE acknowledges Mr. Tanmay Tathagat, Mr. Govinda Somani, Mr. Mayank Bhatnagar, Mr. Hisham Ahmad, Mr. Syed Nabeel Ahmad, Ms. Aarti Nain, Mr. Gurneet Singh, Ms. Anamika Prasad, and the team of architects, engineers and renewable energy experts from Environmental Design Solutions. The code requirements and stringency for ECBC 2017 were informed by their research and analytical studies.

ECBC 2017 would not have been possible without the commitment and support of officers from BEE beginning with the former Director General Dr. Ajay Mathur, former Energy Economist Mr. Sanjay Seth, former Assistant Energy Economist Mr. Girja Shankar, Assistant Energy Economist Mr. Arijit Sengupta and Project Engineers Ms. Anju Singh, Mr. Niral Rajesh Modi, and Mr. Ishan Jain.

BEE also appreciates the stakeholders from the building industry in India who have provided constant feedback on improving ECBC. I do hope that an endeavour that involved collaborative efforts of so many will be instrumental in encouraging efficiency in buildings in India.

Saurabh Diddi

Energy Economist
Bureau of Energy Efficiency

Mark A. White

Mission Director, USAID



Energy cooperation is a key element of the U.S.-India strategic partnership. The two countries have been working together to accelerate clean energy deployment and ensure energy security since the 1950s. The most recent partnership between the U.S. and India, the Partnership to Advance Clean Energy – Deployment (PACE-D), was initiated in 2009 to leverage skills and resources of agencies from both the U.S. and India for scaling up deployment of energy efficiency and renewable energy technologies in India.

The U.S. Agency for International Development (USAID) and the Bureau of Energy Efficiency, Ministry of Power has a long standing and fruitful partnership in enhancing energy efficiency of buildings in India. In 2007, USAID supported the development of the Energy Conservation Building Code (ECBC) in 2007 under the Energy Conservation and Commercialization (ECO) II bilateral program. With PACE-D, we have extended this partnership in a logical direction through technical assistance for update of the ECBC 2007 and its implementation in states.

ECBC 2017 supports many of the Government of India's objectives for achieving energy security, economic growth and environmental sustainability. As a primary policy driver for guiding building construction, it is a forward looking code and will push the building sector towards near zero energy targets. USAID is proud to be associated with the Bureau of Energy Efficiency and the Ministry of Power on such a progressive and innovative building energy code, ECBC 2017.

I congratulate the Bureau of Energy Efficiency and the Ministry of Power on the launch of ECBC 2017. India is in a massive construction phase and the code can be a transformative tool for integrating energy efficient design and technologies in all new commercial buildings.



Mark A. White
Mission Director

U.S. Agency for International Development
American Embassy
Chanakyapuri
New Delhi 110 021

Tel: 91-11-24198000
Fax: 91-11-24198612
www.usaid.gov/in

Energy Conservation Building Code 2017 Committees and Working Groups

Steering Committee

B. P. Pandey, Director General, Bureau of Energy Efficiency, Chair

Saurabh Diddi, Bureau of Energy Efficiency, Convenor

Meera Shekhar, Bureau of Energy Efficiency

Rajiv Sharma, Bureau of Indian Standards

Sanjay Seth, GRIHA

C. K. Varma, Central Public Works Department

K. K. Joadder, Town & Country Planning Organization

S. Vikash Ranjan, Deutsche Gesellschaft für Internationale Zusammenarbeit

Balkar Singh, Punjab Energy Development Agency

Michel Satin, United States Agency for International Development

N. K. Bansal, Indian Institute of Technology Delhi

R. S. Agarwal, Indian Institute of Technology Delhi

Bhim Singh, Indian Institute of Technology Delhi

Gulshan Aghi, Indian Society of Lighting Engineers

Working Group on Administration and Compliance

Saurabh Diddi, Energy Economist, Bureau of Energy Efficiency, Chair

Arijit Sengupta, Bureau of Energy Efficiency, Convenor

Srinivas Chary, Administrative Staff College of India

K. K. Joadder, Town & Country Planning Organization

C. K. Verma, Central Public Works Department

Sumit Sengar, Bureau of Indian Standards

C. S. Prasad, Indian Building Congress

C. S. Reddy, Confederation of Real Estate Developers Associations of India

N. K. Bansal, Indian Institute of Technology Delhi

R. S. Agarwal, Indian Institute of Technology Delhi

Bhim Singh, Indian Institute of Technology Delhi

Gulshan Aghi, Indian Society of Lighting Engineers

Working Group on Building Envelope

N. K. Bansal, Center for Environmental Planning & Technology, Chair

Arijit Sengupta, Bureau of Energy Efficiency, Convenor

Mili Majumdar, TERI

Rajan Rawal, Center for Environmental Planning & Technology

Prabhakar Singh, Central Public Works Department

Anurag Bajpai, GreenTree

Abdullah Nisar Siddiqui, United Nations Development Programme

Working Group on Lighting and Controls

Late Shri H.S. Mamak, Chair

Gulshan Aghi, Ex- President of Indian Society of Lighting Engineers, Chair

Arijit Sengupta, Bureau of Energy Efficiency, Convenor

Shyam Sujan, ELCOMA

Hemant Kumar Jain, Central Building Research Institute

H C Kandpal, Independent Consultant

H. R. Vaish, Indian Society of Lighting Engineers

P. K. Sood, Indian Society of Lighting Engineers

Prabhakar Singh, Central Public Works Department

Rajeev Sharma, Central Public Works Department

Vishal Garg, International Institute of Information Technology, Hyderabad

Working Group on Comfort Systems and Controls

R. S. Agarwal, Indian Institute of Technology Delhi, Chair

Arijit Sengupta, Bureau of Energy Efficiency, Convenor

G C Modgil, Sterling India

Jyotirmay Mathur, Malaviya National Institute of Technology

Milind V Rane, Indian Institute of Technology Mumbai

Archana Walia, CLASP

Ashish Rakheja, Indian Society of Heating, Refrigerating and Air Conditioning Engineers

Dipak Barma, Indian Society of Heating, Refrigerating and Air Conditioning Engineers

P K Mukherjee, CLASP

R. K. Mehta, Refrigeration and Air-conditioning Manufacturer Association

Rajan Rawal, Center for Environmental Planning & Technology

Seemant Sharma, Refrigeration and Air-conditioning Manufacturer Association

Dipankar Bhattacharya, Refrigeration and Air-conditioning Manufacturer Association

Working Group on Electrical and Renewable

Bhim Singh, Professor and Department Head, IIT Delhi, Chair

Arijit Sengupta, Bureau of Energy Efficiency, Convenor

Arun K Tripathi, Ministry of New and Renewable Energy

Girja Shankar, Energy Efficiency Services Limited

K.N. Hemanth, International Copper Association India

Manas Kundu, International Copper Association India

Prabhakar Singh, Central Public Works Department

Vivek Arora, Indian Electrical and Electronics Manufacturers Association

ECBC 2017 Development Team

Apurva Chaturvedi, USAID

Tanmay Tathagat, Environmental Design Solutions [EDS]

Anamika Prasad, Environmental Design Solutions

Aarti Nain, Environmental Design Solutions

Abhishek Jain, Environmental Design Solutions

Deepa Parekh, Environmental Design Solutions

Dipti Arora, Environmental Design Solutions

Govinda Somani, Environmental Design Solutions

Gurneet Singh, Environmental Design Solutions

Hiren Bhagat, Environmental Design Solutions

Hisham Ahmad, Environmental Design Solutions

Mayank Bhatnagar, Environmental Design Solutions

Nidhi Gupta, Environmental Design Solutions

Nikunj Shukla, Environmental Design Solutions

Piyush Varma, Environmental Design Solutions

Syed Nabeel Ahmad, Environmental Design Solutions

Bhaskar Natarajan, Nexant

Nithyanandam Yuvaraj Dinesh Babu, Nexant

Sujatha Ramasamy, Nexant

Not For Circulation

Technical Reviewers

Administrative Staff College of India – Hyderabad (ASCI)
Alliance for an Energy Efficient Economy (AEEE)
American Society of Heating, Refrigerating and Air-Conditioning Engineers (ASHRAE)
BSES Rajdhani
Center for Environmental Planning and Technology (CEPT)
Central Building Research Institute (CBRI)
Central Public Works Department (CPWD)
CESC Power Utility
CLASP
Confederation of Indian Industry (CII)
Confederation of Real Estate Developers Associations of India (CREDAI)
Department of Energy, Government of Himachal Pradesh
Electric Lamp & Component Manufacturers (ELCOMA)
Environmental Design Solutions [EDS]
Glazing Society of India (GSI)
Green Business Certification Inc. (GBCI)
GRIHA Council
Haryana Renewable Energy Department (HAREDA)
Indian Green Building Council (IGBC)
Indian Institute of Technology Delhi (IIT-Delhi)
Indian Institute of Technology Mumbai
Indian Institute of Technology Roorkee
Indian Insulation Forum (IIF)
Indian Society of Heating Refrigerating and Air Conditioning (ISHRAE)
Indian Society of Lighting Engineers (ISLE)
Indo-EU Building Program
Indo-Swiss Building Energy Efficiency Project (BEEP)
International Copper Association India (ICAI)
International Finance Corporation (IFC)
Lawrence Berkeley National Laboratory (LBNL)
Maharashtra Energy Development Agency (MEDA)
Malaviya National Institute of Technology (MNIT)
Manipal Institute of Technology Manipal
Meghalaya Non-Conventional & Rural Energy Development Agency
Ministry of Urban Development (MoUD)
Ministry of New and Renewable Energy (MNRE)
Municipal Corporation of Mumbai
National Real Estate Development Council (NAREDCO)

Natural Resources Defense Council (NRDC)
New & Renewable Energy Development Corporation of Andhra Pradesh
Rachana Sansad Institute of Environmental Architecture
Refrigeration and Air-Conditioning Manufacturers Association of India (RAMA)
School of Planning and Architecture, Delhi (SPA)
State Designated Agency, Odisha
Swiss Agency for Development and Cooperation (SDC)
Tata Power Delhi Distribution Limited
The Energy and Resources Institute (TERI)
The Indian Institute of Architects (IIA)
The Indian Institute of Engineers (IIE)
United Nations Development Programme (UNDP)
United States Agency for International Development (USAID)
Uttarakhand Renewable Energy Development Agency
West Bengal Renewable Energy Development Agency

Not For Circulation



ECBC

Energy
Conservation
Building
Code 2017

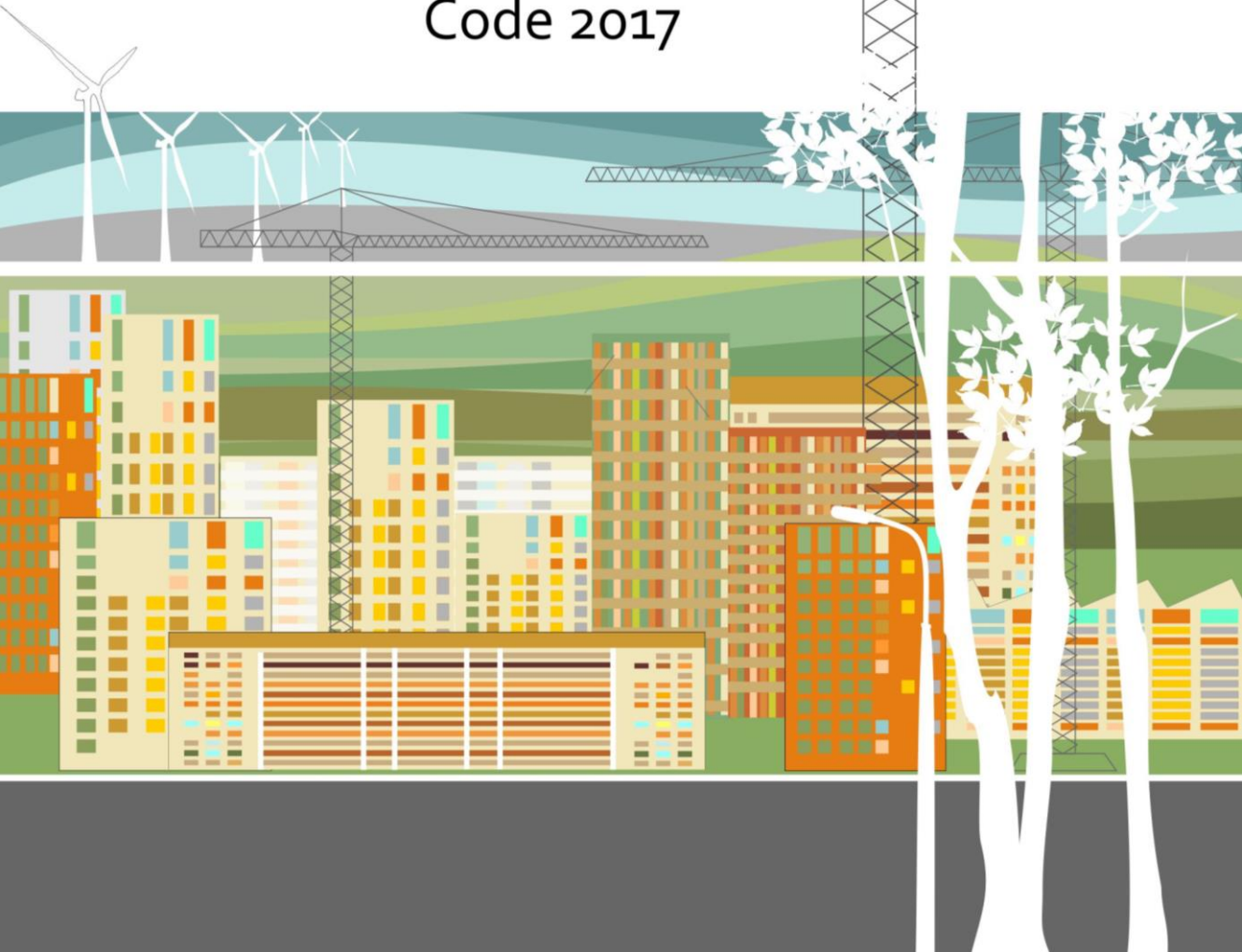

Contents

1. Purpose.....	2
2. Scope	4
2.1 Energy Efficiency Performance Levels	4
2.2 Building Systems.....	4
2.3 Precedence	5
2.4 Reference Standards	5
2.5 Building Classification	5
3. Compliance and Approach.....	10
3.1 General	10
3.1.1 Energy Performance Index.....	10
3.1.2 Determining EPI Ratio.....	10
3.2 Compliance Approaches.....	12
3.2.1 Mandatory Requirements.....	12
3.2.2 Prescriptive Method	12
3.2.3 Whole Building Performance Method	12
3.3 Compliance Requirements	12
3.3.1 New Building Compliance	12
3.3.2 Additions to Existing Buildings.....	13
3.3.3 Alterations to Existing Buildings	13
3.4 Approved Analytical Tools	13
3.5 Administrative Requirements.....	14
3.6 Compliance Documents.....	14
3.6.1 Compliance Documents.....	14
3.6.2 Supplemental Information.....	14
4. Building Envelope	16
4.1 General	16

4.2	Mandatory Requirements	16
4.2.1	Fenestration	16
4.2.2	Opaque Construction	16
4.2.3	Daylighting.....	17
4.2.4	Building Envelope Sealing.....	19
4.3	Prescriptive Requirements	22
4.3.1	Roof	22
4.3.2	Opaque External Wall.....	23
4.3.3	Vertical Fenestration	23
4.3.4	Skylights.....	29
4.3.5	Building Envelope Trade-Off Method.....	30
4.3.6	Standard Building EPF Calculation.....	32
5.	Comfort Systems and Controls.....	38
5.1	General.....	38
5.2	Mandatory Requirements	38
5.2.1	Ventilation	38
5.2.2	Minimum Space Conditioning Equipment Efficiencies.....	40
5.2.3	Controls	42
5.2.4	Additional Controls for ECBC+ and SuperECBC Buildings	44
5.2.5	Additional Controls for SuperECBC Buildings	45
5.2.6	Piping and Ductwork	45
5.2.7	System Balancing.....	47
5.2.8	Condensers.....	48
5.2.9	Service Water Heating.....	48
5.3	Prescriptive Requirements	49
5.3.1	Pumps.....	50
5.3.2	Cooling Towers	51
5.3.3	Economizers	51
5.3.4	Variable Flow Hydronic Systems	52
5.3.5	Boilers.....	53
5.3.6	Energy Recovery	53

5.4	Total System Efficiency – Alternate Compliance Approach.....	53
5.5	Low-energy Comfort Systems.....	54
6.	Lighting and Controls.....	58
6.1	General	58
6.2	Mandatory Requirements	58
6.2.1	Lighting Control.....	58
6.2.2	Exit Signs	60
6.3	Prescriptive Requirements	61
6.3.1	Interior Lighting Power	61
6.3.2	Building Area Method.....	62
6.3.3	Space Function Method.....	64
6.3.4	Installed Interior Lighting Power	70
6.3.5	Exterior Lighting Power.....	70
7.	Electrical and Renewable Energy Systems.....	74
7.1	General	74
7.2	Mandatory Requirements	74
7.2.1	Transformers.....	74
7.2.2	Energy Efficient Motors	77
7.2.3	Diesel Generator (DG) Sets	77
7.2.4	Check-Metering and Monitoring	78
7.2.5	Power Factor Correction.....	79
7.2.6	Power Distribution Systems.....	79
7.2.7	Uninterruptible Power Supply (UPS)	79
7.2.8	Renewable Energy Systems	79
8.	Definitions, Abbreviations, and Acronyms	82
8.1	General	82
8.2	Definitions	82
8.3	SI to IP Conversion Factors	102
8.4	Abbreviations and Acronyms.....	103
9.	Whole Building Performance Method.....	106
9.1	General	106

9.1.1	Scope	106
9.1.2	Compliance	106
9.1.3	Annual Energy Use	106
9.1.4	Trade-offs Limited to Building Permit	106
9.1.5	Documentation Requirements	106
9.2	Mandatory Requirements	107
9.3	Simulation Requirements	107
9.3.1	Energy Simulation Program	107
9.3.2	Climate Data	108
9.3.3	Compliance Calculations	108
9.4	Calculating Energy Consumption of Proposed Design and Standard Design	108
9.4.1	Energy Simulation Model	108
9.4.2	HVAC Systems	108
9.4.3	Compliance Thresholds for ECBC compliant, ECBC+ and SuperECBC Buildings 118	
9.5	Maximum Allowed EPI Ratios	119
9.6	Schedules	122
10.	Appendix A: Default Values for Typical Constructions	148
10.1	Procedure for Determining Fenestration Product U-factor and Solar Heat Gain Coefficient	148
10.2	Default U-factors and Solar Heat Gain Coefficients for Unrated Fenestration Products	149
10.2.1	Unrated Vertical Fenestration	149
10.2.2	Unrated Sloped Glazing and Skylights	149
10.3	Typical Roof Constructions	150
10.4	Typical Wall Constructions	150
11.	Appendix B: Climate Zone Map of India	155
12.	Appendix C: Air-Side Economizer Acceptance Procedures	157
12.1	Construction Inspection	157
12.2	Equipment Testing	157
13.	Appendix D: Compliance Forms	158
14.	Appendix E: BEE approved list of software to show compliance	170

List of Tables

Table 4-1 Daylight Requirement	17
Table 4-2 Default Values for Surface Reflectance	18
Table 4-3 Daylight Extent Factors (DEF) for Manually Calculating Daylight Area	18
Table 4-4 Roof Assembly U-factor ($W/m^2.K$) Requirements for ECBC Compliant Building	22
Table 4-5 Roof Assembly U-factor ($W/m^2.K$) Requirements for ECBC+ Compliant Building ..	22
Table 4-6 Roof Assembly U-factor ($W/m^2.K$) Requirements for SuperECBC Building.....	22
Table 4-7 Opaque Assembly Maximum U-factor ($W/m^2.K$) Requirements for a ECBC compliant Building	23
Table 4-8 Opaque Assembly Maximum U-factor ($W/m^2.K$) Requirements for ECBC+ Compliant Building	23
Table 4-9 Opaque Assembly Maximum U-factor ($W/m^2.K$) Requirements for SuperECBC Building	23
Table 4-10 Vertical Fenestration Assembly U-factor and SHGC Requirements for ECBC Buildings	24
Table 4-11 Vertical Fenestration U-factor and SHGC Requirements for ECBC+ buildings and SuperECBC buildings	24
Table 4-12 Coefficients of Shading Equivalent Factors for Latitudes greater than or equal to $15^{\circ}N$	25
Table 4-13 Coefficients of Shading Equivalent Factors for Latitudes less than $15^{\circ}N$	26
Table 4-14 U-factor ($W/m^2.K$) Exemption Requirements for Shaded Building.....	29
Table 4-15 Skylight U-factor and SHGC Requirements (U-factor in $W/m^2.K$)	29
Table 4-16 Envelope Performance Factor Coefficients – Composite Climate	31
Table 4-17 Envelope Performance Factor Coefficients – Hot and Dry Climate	31
Table 4-18 Envelope Performance Factor Coefficients – Hot Humid Climate	31
Table 4-19 Envelope Performance Factor Coefficients – Temperate Climate.....	32
Table 4-20 Envelope Performance Factor Coefficients – Cold Climate	32
Table 5-1 Minimum Energy Efficiency Requirements for water cooled Chillers	41
Table 5-2 Minimum Energy Efficiency Requirements for air cooled Chillers	41
Table 5-3 Minimum Requirements for Unitary, Split, Packaged Air Conditioners in ECBC Building	41
Table 5-4 Minimum Requirements for Unitary, Split, Packaged Air Conditioners in ECBC+ Building	41

Table 5-5 Minimum Requirements for Unitary, Split, Packaged Air Conditioners in SuperECBC Building.....	41
Table 5-6 Minimum Efficiency Requirements for VRF Air conditioners for ECBC Building* ...	42
Table 5-7 Minimum Efficiency Requirements for Computer Room Air Conditioners	42
Table 5-8 Insulation Requirements for Pipes in ECBC Building	46
Table 5-9 Insulation Requirements for Pipes in ECBC+ Building	46
Table 5-10 Insulation Requirements for Pipes in SuperECBC Buildings	47
Table 5-11 Ductwork Insulation (R value in m ² . K/W) Requirements	47
Table 5-12 Mechanical and Motor Efficiency Requirements for Fans in ECBC Buildings.....	50
Table 5-13 Mechanical and Motor Efficiency Requirements for Fans in ECBC+ Buildings.....	50
Table 5-14 Mechanical and Motor Efficiency Requirements for Fans in SuperECBC Buildings	50
Table 5-15 Pump Efficiency Requirements for ECBC Building.....	50
Table 5-16 Pump Efficiency Requirements for ECBC+ Building.....	51
Table 5-17 Pump Efficiency Requirements for SuperECBC Building	51
Table 5-18 Cooling Tower Efficiency Requirements for ECBC, ECBC+, and SuperECBC Buildings.....	51
Table 5-19 Minimum Efficiency Requirements for Oil and Gas Fired Boilers for ECBC building	53
Table 5-20 Minimum Efficiency Requirements for Oil and Gas Fired Boilers for ECBC+ and SuperECBC building.....	53
Table 5-21 Minimum System Efficiency* Requirement for ECBC, ECBC+, and SuperECBC Buildings	54
Table 6-1 Interior Lighting Power for ECBC Buildings – Building Area Method	62
Table 6-2 Interior Lighting Power for ECBC+ Buildings – Building Area Method	63
Table 6-3 Interior Lighting Power for SuperECBC Buildings – Building Area Method	63
Table 6-4 Interior Lighting Power for ECBC Buildings – Space Function Method	64
Table 6-5 Interior Lighting Power for ECBC+ Buildings – Space Function Method	66
Table 6-6 Interior Lighting Power for SuperECBC Buildings – Space Function Method	67
Table 6-7 Exterior Building Lighting Power for ECBC Buildings	71
Table 6-8 Exterior Building Lighting Power for ECBC+ Buildings	71
Table 6-9 Exterior Building Lighting Power for SuperECBC Buildings.....	71
Table 7-1 Dry Type Transformers	75

Table 7-2 Permissible Losses for Oil Type Transformers. Total losses for oil type transformers shall confirm with Indian Standard IS 1180	76
Table 7-3 Sub Metering Requirements.....	78
Table 7-4 Energy Efficiency Requirements for UPS for ECBC, ECBC+, SuperECBC building	79
Table 7-5 Minimum Solar Zone Area/Renewable Energy Generating Zone Requirement for ECBC+ Building.....	80
Table 7-6 Minimum Solar Zone Area/Renewable Energy Generating Zone Requirement for SuperECBC Building	80
Table 9-1 Modelling Requirements for Calculating Proposed and Standard Design.....	109
Table 9-2 HVAC Systems Map for Standard Design.....	114
Table 9-3 Modeling Requirements for Calculating Proposed and Standard Design.....	116
Table 9-4 Power Adjustment Factors for Automatic Lighting Controls.....	118
Table 9-5 Maximum Allowed EPI Ratios for Building in Composite Climate	119
Table 9-6 Maximum Allowed EPI Ratios for Buildings in Hot and Dry Climate.....	119
Table 9-7 Maximum Allowed EPI Ratios for Buildings in Temperate Climate	120
Table 9-8 Maximum Allowed EPI Ratios for Buildings in Warm and Humid Climate	120
Table 9-9 Maximum Allowed EPI Ratios for Buildings in Cold Climate.....	121
Table 9-10 Schedules for Business Buildings.....	122
Table 9-11 Schedules for Assembly Buildings.....	123
Table 9-12 Schedules for Business - Office Buildings.....	124
Table 9-13 Schedules for Educational - School Buildings (A).....	125
Table 9-14 Schedules for Educational - University Buildings (A)	127
Table 9-15 Schedules for Healthcare - Hospital Buildings (A).....	129
Table 9-16 Schedules for Healthcare – Out-patient Healthcare Buildings (A).....	132
Table 9-17 Schedules for Hospitality Buildings (A)	134
Table 9-18 Schedules for Shopping Complexes Buildings (A)	139
Table 9-19 Schedules for Shopping Complex- Strip Retail & Supermall Buildings (A)	142
Table 9-20 Schedules for Shopping Complex- Strip Retail & Supermall Buildings (A)	143
Table 9-21 Schedules for Assembly Buildings.....	144
Table 9-22 Schedules for Business - Office Buildings.....	145
Table 10-1 Defaults for Unrated Vertical Fenestration (Overall Assembly including the Sash and Frame).....	149

Table 10-2 Typical Thermal Properties of Common Building and Insulating Materials	151
Table 11-1 Climate Zone for Major Indian Cities.....	156
Table 14-1 Bureau of Energy Efficiency Approved Software for Demonstrating Compliance with ECBC	170

BEE Copy - Not For Circulation

List of Notes

Note 2-1 Building Typologies for ECBC 2017	7
Note 4-1 Daylight Extent Factor and Useful Daylight Illuminance	20
Note 4-2 Equivalent SHGC and Projection Factor.....	27
Note 4-3 Building Envelope Trade-off Method	33
Note 5-1 Adaptive Thermal Comfort	39
Note 5-2 Thermal Energy Storage	55
Note 6-1 Calculating Interior Lighting Power – Space Function Method	69

BEE Copy - Not For Circulation

1 Purpose



1. Purpose

The purpose of the Energy Conservation Building Code (Code) is to provide minimum requirements for the energy-efficient design and construction of buildings. The Code also provides two additional sets of incremental requirements for buildings to achieve enhanced levels of energy efficiency that go beyond the minimum requirements.

BEE Copy - Not For Circulation

2. Scope

The Code is applicable to buildings or building complexes that have a connected load of 100 kW or greater or a contract demand of 120 kVA or greater and are intended to be used for commercial purposes.

Buildings intended for private residential purposes only are not covered by the Code.

2.1 Energy Efficiency Performance Levels

The code prescribes the following three levels of energy efficiency:

- (a) Energy Conservation Building Code Compliant Building (ECBC Building)
ECBC Buildings shall demonstrate compliance by adopting the mandatory and prescriptive requirements listed under ECBC Compliant Building requirements in §4 to §7, or by following the provisions of the Whole Building Performance (WBP) Method in §9.
- (b) Energy Conservation Building Code Plus Building (ECBC+ Building)
ECBC+ Buildings shall demonstrate compliance by adopting the mandatory and prescriptive requirements listed under ECBC+ Compliant Building requirements in §4 to §7, or by following the provisions of the Whole Building Performance (WBP) Method in §9.
- (c) Super Energy Conservation Building Code Building (SuperECBC Building)
SuperECBC Buildings shall demonstrate compliance by adopting the mandatory and prescriptive requirements listed under SuperECBC Compliant Building requirements in §4 to §7, or by following the provisions of the Whole Building Performance (WBP) Method in §9.

2.2 Building Systems

The provisions of this code apply to:

- (a) Building envelope,
- (b) Mechanical systems and equipment, including heating, ventilating, and air conditioning, service hot water heating,
- (c) Interior and exterior lighting, and
- (d) Electrical power and motors, and renewable energy systems.

The provisions of this code do not apply to plug loads, and equipment and parts of buildings that use energy for manufacturing processes, unless otherwise specified in the Code.

2.3 Precedence

The following codes, programs, and policies will take precedence over the Code in case of conflict:

- (d) Any policy notified as taking precedence over this Code, or any other rules on safety, security, health, or environment by Central, State, or Local Government.
- (e) Bureau of Energy Efficiency's Standards and Labelling for appliances and Star Rating Program for buildings, provided both or either are more stringent than the requirements of this Code.

2.4 Reference Standards

The National Building Code of India 2016 (NBC) is the reference standard for lighting levels, heating, ventilating, and air conditioning (HVAC), thermal comfort conditions, natural ventilation, and any other building materials and system design criteria addressed in this Code.

2.5 Building Classification

Any one or more building or part of a building with commercial use is classified as per the functional requirements of its design, construction, and use. The key classification is as below:

- (a) **Hospitality:** Any building in which sleeping accommodation is provided for commercial purposes, except any building classified under Health Care. Buildings and structures under Hospitality shall include the following:
 - i. No-star Hotels – like Lodging-houses, dormitories, no-star hotels/motels
 - ii. Resort
 - iii. Star Hotel
- (b) **Health Care:** Any building or part thereof, which is used for purposes such as medical or other treatment or care of persons suffering from physical or mental illness, disease, or infirmity; care of infants, convalescents, or aged persons, and for penal or correctional detention in which the liberty of the inmates is restricted. Health Care buildings ordinarily provide sleeping accommodation for the occupants. Buildings and structures like hospitals, sanatoria, out-patient healthcare, laboratories, research establishments, and test houses are included under this type.
- (c) **Assembly:** Any building or part of a building, where number of persons congregate or gather for amusement, recreation, social, religious, patriotic, civil, travel and similar purposes. Buildings like theatres or motion picture halls, gathering halls, and transport buildings like airports, railway stations, bus stations, and underground and elevated mass rapid transit system are included in this group.

- (d) **Business:** Any building or part thereof which is used for transaction of business, for keeping of accounts and records and similar purposes, professional establishments, and service facilities. There are two subcategories under Business – Daytime Business and 24-hour Business. Unless otherwise mentioned, Business buildings shall include both Daytime and 24-hour subcategories.
- (e) **Educational:** Any building used for schools, colleges, universities, and other training institutions for day-care purposes involving assembly for instruction, education, or recreation for students. If residential accommodation is provided in the schools, colleges, or universities or coaching/ training institution, that portion of occupancy shall be classified as a No-star Hotel. Buildings and structures under Educational shall include following types-
- i. Schools
 - ii. Colleges
 - iii. Universities
 - iv. Training Institutions
- (f) **Shopping Complex:** Any building or part thereof, which is used as shops, stores, market, for display and sale of merchandise, either wholesale or retail. Buildings like shopping malls, stand-alone retails, open gallery malls, super markets, or hyper markets are included in this type.
- (g) **Mixed-use Building:** In a mixed-use building, each commercial part of a building must be classified separately, and –
- i. If a part of the mixed-use building has different classification and is less than 10% of the total above grade floor area, the mixed-use building shall show compliance based on the building sub-classification having higher percentage of above grade floor area.
 - ii. If a part of the mixed-use building has different classification and one or more sub-classification is more than 10% of the total above grade floor area, the compliance requirements for each sub-classification, having area more than 10% of above grade floor area of a mixed-use building shall be determined by the requirements for the respective building classification in §4 to §7.

Any building which does not fall under any of the categories defined above shall be classified in a category mentioned above that best describes the function of the building.

Note 2-1 Building Typologies for ECBC 2017



Energy efficiency requirements for the Code were derived after analysing 16 different non-residential building typologies (shown below), that in turn are broadly based on building classification in the National Building Code of India. Spatial layouts, material specifications, façade characteristics, and occupancy patterns have an impact on energy efficiency of a building and differ for these typologies. Potential for reducing energy use with technology and materials thus varies from building type to type. By analysing this potential,

ECBC energy efficiency requirements are now sensitive to building typologies and, to the extent possible, only requirements that are feasible have been included.



Hospitality

1. Star Hotel
2. No Star Hotel
3. Resort



Educational

1. College
2. University
3. Institution
4. School



Health Care

1. Hospital
2. Out-patient Healthcare



Shopping Complex

1. Shopping Mall
2. Stand-alone Retails
3. Open Gallery Malls
4. Super Markets

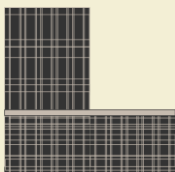

Business

1. Large Office (>30,000 m²)
2. Medium Office (10,000m²-30,000 m²)
3. Small Office (<10,000 m²)



Assembly

1. Multiplex
2. Theatre
3. Building used for Transport Services



3 Compliance & Approach



3. Compliance and Approach

3.1 General

To comply with the Code, buildings shall

- (a) have an Energy Performance Index Ratio (EPI Ratio) as defined in §3.1.1 that is less than or equal to 1
- and,
- (b) meet all mandatory requirements mentioned under §4.2, §5.2, §6.2, and §7.2.

3.1.1 Energy Performance Index

The Energy Performance Index (EPI) of a building is its annual energy consumption in kilowatt-hours per square meter of the building. While calculating the EPI of a building, the area of unconditioned basements shall not be included. EPI can be determined by:

$$EPI = \frac{\text{annual energy consumption in kWh}}{\text{total built - up area (excluding unconditioned basements)}}$$

To comply with the Code, EPI shall be calculated based on one of the following:

- (a) Prescriptive Method including Building Envelope Trade-off Method (see §3.2.2)
- (b) Whole Building Performance Method (see §3.2.3)

3.1.2 Determining EPI Ratio

The EPI Ratio of a building is the ratio of the EPI of the Proposed Building to the EPI of the Standard Building:

$$EPI \text{ Ratio} = \frac{EPI \text{ of Proposed Building}}{EPI \text{ of Standard Building}}$$

where,

Proposed Building is consistent with the actual design of the building, and complies with all the mandatory requirements of ECBC.

Standard Building is a standardized building that has the same building floor area, gross wall area and gross roof area as the Proposed Building, complies with the mandatory requirements §4.2, §5.2, §6.2, and §7.2, and minimally complies with prescriptive requirements of §4.3, §5.3, and §6.3 for ECBC Buildings.

The EPI of the Proposed Building shall be established through any one of the following two methods described in §3.2 –

- (a) Prescriptive Method (see §3.2.2)
- (b) Whole Building Performance Method (see §3.2.3)

3.1.2.1 EPI Ratio through Prescriptive Method

ECBC Buildings that demonstrate compliance through Prescriptive Method (§3.2.2) shall be deemed to have an EPI equal to the Standard Building EPI, and therefore an EPI Ratio of 1. ECBC+ Buildings and SuperECBC Buildings that demonstrate compliance through Prescriptive Method shall be deemed to have an EPI Ratio equal to the EPI Ratios listed in §9.5 under the applicable building type and climate zone.

3.1.2.2 EPI Ratio through Whole Building Performance Method

The EPI of buildings that demonstrate compliance through Whole Building Performance Method (§3.2.3) shall be calculated using the compliance path defined in §3.1.1 and detailed in §9. The EPI Ratio of a building that uses the Whole Building Performance Method to show compliance, should be less than or equal to the EPI Ratio listed in §9.5 for the applicable building type and climate zone.

3.1.2.3 EPI Ratio for Core and Shell Buildings

EPI for core and shell buildings shall be calculated for the entire building based on the final design of the common areas and the relevant mandatory undertaking(s) in the tenant lease agreement for the leased areas, as per §3.1.2.1 or §3.1.2.2.

3.1.2.4 EPI Ratio for Mixed-use Development

In a mixed-use building, each commercial part of a building must be classified separately, and EPI Ratio shall be calculated separately for each sub-classification, as per §3.1.2.1 or §3.1.2.2. The EPI Ratio of a mixed-use Proposed Building shall be calculated based on area-weighted average method. To calculate the reference maximum design EPI Ratio, listed in Table 9-5 through Table 9-7, applicable for the mixed-use building, each commercial part of mixed-use building shall be classified separately, and,

- (a) If a part of the mixed-use building has different classification and is less than 10% of the total above grade area (AGA), the EPI Ratio of the mixed-use Proposed Building shall be less than or equal to Maximum Allowed EPI listed in Table 9-5 through Table 9-7, for the building sub-classification having highest percentage of above grade floor area.
- (b) If a part of the mixed-use building has different classification and is more than 10% of the total above grade floor area, the EPI of the mixed-use Proposed Building shall be less than or equal to Maximum Allowed EPI for compliance calculated based on area weighted average method for all building sub-classifications listed in Table 9-5 through Table 9-7.

Exceptions to the above: Any portion of a mixed-use building classified in a category which does not fall under the scope of ECBC is exempted from demonstrating compliance.

3.2 Compliance Approaches

Buildings that fall within the scope of the Code as mentioned in §2, shall comply with the Code by meeting all the mandatory requirements (see §3.2.1) and any of the compliance paths mentioned in §3.2.2, §3.2.2.1, or §3.2.3.

3.2.1 Mandatory Requirements

Buildings shall comply with all mandatory requirements mentioned under §4.2, §5.2, §6.2, and §7.2, irrespective of the compliance path.

3.2.2 Prescriptive Method

A building complies with the Code using the Prescriptive Method if it meets the prescribed minimum (or maximum) values for envelope components (§4.3), comfort systems and controls (§5.3, §5.4, §5.5), and lighting and controls (§6.3), in addition to meeting all the mandatory requirements.

3.2.2.1 Building Envelope Trade-off Method

Building Envelope Trade-off Method may be used in place of the prescriptive criteria of §4.3.1, §4.3.2 and §4.3.3. A building complies with the Code using the Building Envelope Trade-off Method if the Envelope Performance Factor (EPF) of the Proposed Building is less than or equal to the EPF of the Standard Building, calculated as per §4.3.5, in addition to meeting the prescriptive requirements for comfort systems and controls (§5.3, §5.4), and lighting and controls (§6.3), and all the mandatory requirements (§4.2, §5.2, §6.2 and §7.2).

3.2.3 Whole Building Performance Method

A building complies with the Code using the Whole Building Performance (WBP) Method when the estimated annual energy use of the Proposed Design is less than that of the Standard Design, even though it may not comply with the specific provisions of the prescriptive requirements in §4 through §7. The mandatory requirements of §4 through §7 (§4.2, §5.2, §6.2, and §7.2) shall be met when using the WBP Method.

3.3 Compliance Requirements

3.3.1 New Building Compliance

3.3.1.1 Full building Compliance

New buildings with completed fit-outs shall comply with either the provisions of §4 through §7 of this Code or the Whole Building Performance Method of §9.

3.3.1.2 Core and Shell building Compliance

New core and shell building shall demonstrate compliance with ECBC requirements for the following base building systems in the common areas:

- (a) Building envelope
- (b) Thermal comfort systems and controls (only those installed by developer/ owner)
- (c) Lighting systems and controls (only those installed by developer/ owner)
- (d) Electrical systems (installed by developer/ owner)
- (e) Renewable energy systems

Additionally, the tenant lease agreement shall have a legal undertaking clause to ensure interior fit-outs made by tenant shall be Code compliant. The legal undertaking shall mandate the relevant energy efficiency compliance requirements for all interior fit-outs within the tenant leased area, including, but not limited to, §5.2.1, §5.2.2.2, §5.2.2.3, §5.2.3, §6, and §7.2.4.

3.3.2 Additions to Existing Buildings

Where the new connected load demand of the addition plus the existing building exceeds 100 kW or 120 kVA, the additions shall comply with the provisions of §4 through §7. Compliance may be demonstrated in either of the following ways:

- (a) The addition shall comply with the applicable requirements, or
- (b) The addition, together with the entire existing building, shall comply with the requirements of this Code that shall apply to the entire building, as if it were a new building.

Exceptions to §3.3.2: When space conditioning is provided by existing systems and equipment, the existing systems and equipment need not comply with this code. However, any new equipment installed must comply with specific requirements applicable to that equipment.

3.3.3 Alterations to Existing Buildings

Where the connected load or contract demand of the existing building exceeds 100 kW or 120 kVA respectively, part of a building and its systems that are being altered shall meet the provisions of §4 through §7.

Exception to §3.3.3: When the entire building complies with all of the provisions of §4 through §7, as if it were a new building.

3.4 Approved Analytical Tools

A building following the whole building performance approach shall show compliance through a whole building energy simulation software that has been approved by BEE. Compliance to the daylight requirements of §4.2.3, if calculated through software tools, shall be shown through a daylighting software approved by BEE. The list of BEE approved

software for whole building energy simulation and daylighting analysis is given in Appendix E.

3.5 Administrative Requirements

Administrative requirements, including but not limited to, permit requirements, enforcement, interpretations, claims of exemption, approved calculation methods, and rights of appeal are specified by the authority having jurisdiction.

3.6 Compliance Documents

3.6.1 Compliance Documents

Construction drawings and specifications shall show all pertinent data and features of the building, equipment, and systems in sufficient detail to permit the authority having jurisdiction to verify that the building complies with the requirements of this code. Details shall include, but are not limited to:

- (a) Building Envelope: opaque construction materials and their thermal properties including thermal conductivity, specific heat, density along with thickness; fenestration U-factors, solar heat gain coefficients (SHGC), visible light transmittance (VLT) and building envelope sealing documentation; overhangs and side fins, building envelope sealing details;
- (b) Heating, Ventilation, and Air Conditioning: system and equipment types, sizes, efficiencies, and controls; economizers; variable speed drives; piping insulation; duct sealing, insulation and location; solar water heating system; requirement for balance report;
- (c) Lighting: lighting schedule showing type, number, and wattage of lamps and ballasts; automatic lighting shutoff, occupancy sensors, and other lighting controls; lamp efficacy for exterior lamps;
- (d) Electrical Power: electric schedule showing transformer losses, motor efficiencies, and power factor correction devices; electric check metering and monitoring system.
- (e) Renewable energy systems: system peak generation capacity, technical specifications, solar zone area

3.6.2 Supplemental Information

The authority having jurisdiction may require supplemental information necessary to verify compliance with this code, such as calculations, worksheets, compliance forms, manufacturer's literature, or other data.

4 Building Envelope

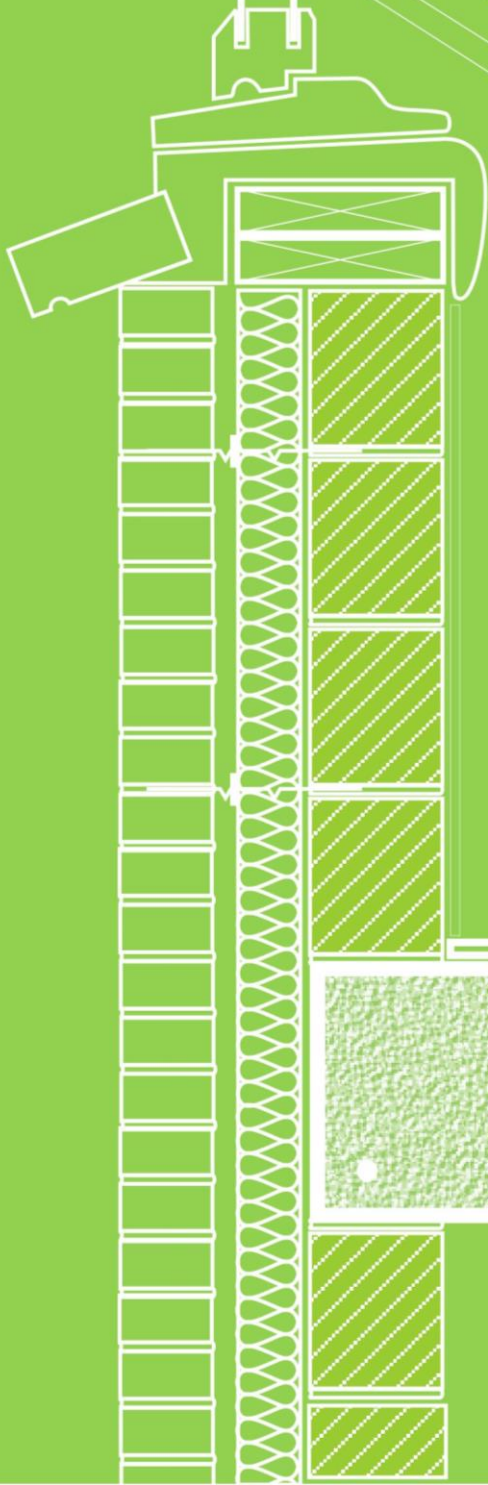

4. Building Envelope

4.1 General

The building envelope shall comply with the mandatory provisions of §4.2, and the prescriptive criteria of §4.3.

4.2 Mandatory Requirements

4.2.1 Fenestration

4.2.1.1 U-Factor

U-factors shall be determined for the overall fenestration product (including the sash and frame) in accordance with ISO-15099 by an accredited independent laboratory, and labeled or certified by the manufacturer. U-factors for sloped glazing and skylights shall be determined at a slope of 20 degrees above the horizontal. For unrated products, use the default table in Appendix A.

4.2.1.2 Solar Heat Gain Coefficient

SHGC shall be determined for the overall single or multi glazed fenestration product (including the sash and frame) in accordance with ISO-15099 by an accredited independent laboratory, and labeled or certified by the manufacturer.

Exceptions to §4.2.1.2:

- (a) Shading coefficient (SC) of the center of glass alone multiplied by 0.86 is an acceptable alternate for compliance with the SHGC requirements for the overall fenestration area.
- (b) Solar heat gain coefficient (SHGC) of the glass alone is an acceptable alternate for compliance with the SHGC requirements for the overall fenestration product.

4.2.1.3 Visual Light Transmittance

Visual light transmittance (VLT) shall be determined for the fenestration product in accordance with ISO-15099 by an accredited independent laboratory, and labeled or certified by the manufacturer. For unrated products, use the default table in Appendix A.

4.2.2 Opaque Construction

U-factors shall be calculated for the opaque construction in accordance with ISO-6946.

Testing shall be done in accordance with approved ISO Standard for respective insulation

type by an accredited independent laboratory, and labeled or certified by the manufacturer. For unrated products, use the default tables in Appendix A.

4.2.3 Daylighting

Above grade floor areas shall meet or exceed the useful daylight illuminance (UDI) area requirements listed in Table 4-1 for 90% of the potential daylight time in a year. Mixed-use buildings shall show compliance as per the criteria prescribed in §2.5. Compliance shall be demonstrated either through daylighting simulation method in §4.2.3.1 or the manual method in §4.2.3.2. Assembly buildings and other buildings where daylighting will interfere with the functions or processes of 50% (or more) of the building floor area, are exempted from meeting the requirements listed in Table 4-1.

Table 4-1 Daylight Requirement

Building Category	Percentage of above grade floor area meeting the UDI requirement		
	ECBC	ECBC+	SuperECBC
Business, Educational	40%	50%	60%
No Star Hotel Star Hotel Healthcare	30%	40%	50%
Resort	45%	55%	65%
Shopping Complex	10%	15%	20%
Assembly*	Exempted		

*and other buildings where daylighting will interfere with the functions or processes of 50% (or more) of the building floor area

4.2.3.1 Daylighting Simulation Method

Only BEE approved software shall be used to demonstrate compliance through the daylighting simulation method. Buildings shall achieve illuminance level between 100 lux and 2,000 lux for the minimum percentage of floor area prescribed in Table 4-1 for at least 90% of the potential daylight time. Illuminance levels for all spaces enclosed by permanent internal partitions (opaque, translucent, or transparent) with height greater or equal to 2 m from the finished floor, shall be measured as follows:

- (a) Measurements shall be taken at a work plane height of 0.8 m above the finished floor.
- (b) The period of analysis shall be fixed for 8 hours per day, anytime between 8:00 AM IST to 5:00 PM IST, resulting in 2,920 hours in total for all building types except for Schools. Schools shall be analyzed for 7 hours per day, anytime between 7:00 AM IST to 3:00 PM IST.
- (c) Available useful daylight across a space shall be measured based on point-by-point grid values. UDI shall be calculated for at least one point for each square meter of floor area.

- (d) Fenestration shall be modeled with actual visible light transmission (VLT) as per the details provided in the material specification sheet.
- (e) All surrounding natural or man-made daylight obstructions shall be modeled if the distance between the façade of the building (for which compliance is shown) and surrounding natural or man-made daylight obstructions is less than or equal to twice the height of the man-made or natural sunlight obstructers. If the reflectance of the surfaces is not known, default reflectance of 30% and 0% shall be used for all vertical surfaces of man-made and natural obstructers respectively.
- (f) Interior surface reflectance shall be modeled based on the actual material specification. If material specification is not available, following default values shall be used:

Table 4-2 Default Values for Surface Reflectance

Surface Type	Reflectance
Wall or Vertical Internal Surfaces	50%
Ceiling	70%
Floor	20%
Furniture (permanent)	50%

4.2.3.2 Manual Daylighting Compliance Method

This method can be used for demonstrating compliance with daylighting requirements without simulation. Daylight extent factors (DEF) mentioned in Table 4-3 shall be used for manually calculating percentage of above grade floor area meeting the UDI requirement for 90% of the potential daylight time in a year.

Table 4-3 Daylight Extent Factors (DEF) for Manually Calculating Daylight Area

Shading	Latitude	Window Type	VLT < 0.3				VLT ≥ 0.3			
			North	South	East	West	North	South	East	West
No shading or PF < 0.4	≥ 15°N	All window types	2.5	2.0	0.7	0.5	2.8	2.2	1.1	0.7
	< 15°N		2.4	2.0	1.3	0.6	1.7	2.2	1.5	0.8
Shading with PF ≥ 0.4	All latitudes	All window types without light shelf	2.8	2.3	1.5	1.1	3.0	2.5	1.8	1.5
		Window with light shelf	3.0	2.5	1.8	1.6	3.5	3.0	2.1	1.8

- (a) To calculate the daylit area:
- i. In a direction perpendicular to the fenestration, multiply daylight extent factor (DEF) by the head height of the fenestration or till an opaque partition higher than head height of the fenestration, whichever is less.
 - ii. In the direction parallel to the fenestration, daylit area extends a horizontal dimension equal to the width of the fenestration plus either 1 meter on each side of the aperture, or the distance to an opaque partition, or one-half the distance to an adjacent fenestration, whichever is least.
 - iii. For skylights, calculate the horizontal dimension in each direction equal to the top aperture dimension in that direction plus either the floor-to-ceiling height (H) for skylights, or 1.5 H for monitors, or H or 2H for the sawtooth configuration, or the distance to the nearest 1 meter or higher opaque partition, or one-half the distance to an adjacent skylight or vertical glazing, whichever is least.
- (b) A separate architectural plan shall be prepared with all daylit areas marked on the floor plans. A summary shall be provided showing compliance as per Table 4-1.
- (c) Glazed façades, with non-cardinal orientation, shall be categorized under a particular cardinal direction if its orientation is within ± 45 degrees of that cardinal direction.
- (d) Any surrounding natural or man-made daylight obstructions shall not be considered in this method.

4.2.4 Building Envelope Sealing

Following areas of the building envelope, of all except naturally ventilated buildings or spaces, shall be sealed, caulked, gasketed, or weather-stripped:

- (a) Joints around fenestration, skylights, and door frames
- (b) Openings between walls and foundations, and between walls and roof, and wall panels
- (c) Openings at penetrations of utility services through roofs, walls, and floors
- (d) Site-built fenestration and doors
- (e) Building assemblies used as ducts or plenums
- (f) All other openings in the building envelope
- (g) Exhaust fans shall be fitted with a sealing device such as a self-closing damper
- (h) Operable fenestration should be constructed to eliminate air leakages from fenestration frame and shutter frame



Useful Daylight Illuminance (UDI) is defined as the annual occurrence of daylight between 100 lux to 2,000 lux on a work plane. This daylight is most useful to occupants, glare free and when available, eliminates the need for artificial lighting.

Application of UDI and Daylight Extent Factor

A 7,200 m² four story office building in Delhi is trying to achieve ECBC level compliance. Building is oriented along east west axis. It has a rectangular layout (60 m x 30 m). Total built up area is distributed evenly across all floors above grade. VLT of glazing in all orientations is 0.39. Windows have light shelves and external shading devices with PF ≥ 0.4. Head height of fenestrations is 3.0 m. Length of glazing on the north and south facing façade is 45 meter and on the east façade, 25 meter.

Table 4-1 lists the minimum daylight area requirements for ECBC Buildings. Row 2 of the table specifies that all ECBC Buildings other than resorts and shopping malls and, more than 3 stories above the ground shall have a minimum of 40% of its floor area exposed to daylight in range of 100 – 2,000 lux for at least 90% of the year.

This office building must then have at least 2,880 m² (40% of 7,200 m²) of floor area fulfilling the UDI requirements. Across each floor plate, this area should be then 2,880/ 4 = 720 m².

Compliance with § 4.2.3 Daylight Requirements can be checked for through two approaches.

(a) Analysis through software

If the whole building performance approach is used, compliance for daylighting requirements can be checked by analysing the façade and floor plate design in an analytical software approved by BEE (§ 3.4). The image below, developed through an approved software, specifies the lux levels and time period of a year during which lighting levels would be available. With this information, designers can check if the required minimum area as per § 4.2.3 has the required daylight levels.

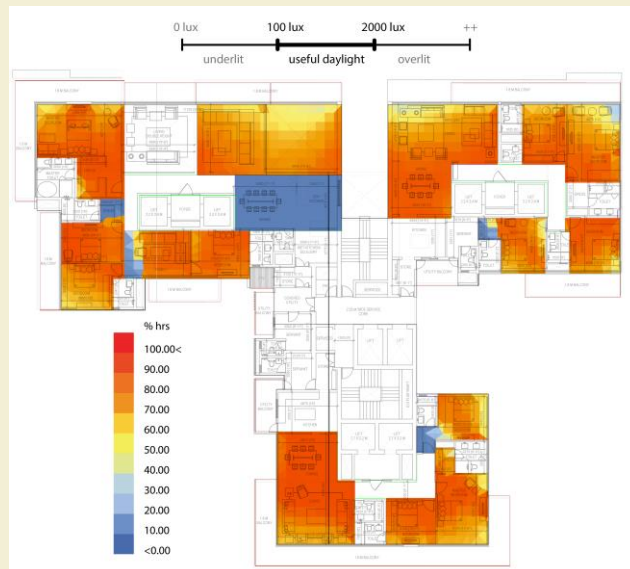

UDI Analysis with a Daylighting Analysis Software

(b) Manual method

This approach will be suitable for projects adopting the prescriptive compliance approach. From Table 4-3 determine the daylight extent factor (DEF) for the building. For a building located in Delhi (latitude > 15 degrees), with glazing of VLT ≥ 0.3, shading PF ≥ 0.4 shading and light shelves in windows, DEFs for windows in North = 3.5, in South = 3.0, in East = 2.1, and in West = 1.8. Head height is 3.0 m. There are no opaque partitions adjacent to the external walls and windows are arranged in a continuous strip.

Area complying with requirements of should be calculated as follows:

In a direction perpendicular to the fenestration, multiply daylight extent factor (DEF) by the head height of the fenestration or till an opaque partition higher than head height of the fenestration, whichever is less. Head height will be considered because there are no opaque partitions near the external walls.

In the direction parallel to the fenestration, daylight area extends a horizontal dimension equal to the width of the fenestration plus either 1 meter on each side of the aperture, or the distance to an opaque partition, or one-half the distance to an adjacent fenestration, whichever is least. In this case, 1 meter on each side of the windows at extreme ends of the window strip in each façade will be considered since there are no opaque partitions adjacent to wall and no opaque area between the windows.

Table 4-1-1 Calculation for Daylight Area Meeting UDI Requirement

<i>Orientation</i>	<i>DEF</i>	<i>Window/ Fenestration Width</i>	<i>X m (distance perpendicular to fenestration)</i>	<i>Y m (distance parallel to fenestration)</i>	<i>(X x Y m²) Above grade area meeting the UDI requirement for 90% of the time in an year</i>
North	3.5	45 m	3.5 x 3 = 10.5 m	(45+2) = 47 m	(47 x 10.5) = 493.5 m ²
South	3.0	45 m	3.0 x 3 = 9.0 m	(45+2) = 47 m	(47 x 9.0) = 423 m ²
East	2.1	25 m	2.1 x 3 = 6.3 m	(25+2) = 27 m	(27 x 6.3) = 170 m ²
West	1.8	0 m (service zone)	0	0	0
Total daylight area per floor meeting UDI requirement during 90% of the year					1086.5 m ²
Total daylight area in building meeting UDI requirement during 90% of the year					1086.5 x 4 = 4,346 m ²

4,346 m² of area will meet the UDI requirements. This is 60.3 % of the total above grade floor area of 7,200 m². Thus, the building will comply with UDI requirement.

Daylight area should be indicated in floor plans submitted to code enforcement authorities. Design guidelines on daylighting stated in NBC (Part 8: Building Services, Section 1: Lighting and Natural Ventilation, Subsection 4.2: Daylighting) should also be referred to achieve the ECBC, ECBC+, or SuperECBC requirement.

4.3 Prescriptive Requirements

4.3.1 Roof

Roofs shall comply with the maximum assembly U-factors in Table 4-4 through Table 4-6. The roof insulation shall be applied externally as part of structural slab and not as a part of false ceiling.

Table 4-4 Roof Assembly U-factor ($W/m^2.K$) Requirements for ECBC Compliant Building

	Composite	Hot and dry	Warm and humid	Temperate	Cold
All building types, except below	0.33	0.33	0.33	0.33	0.28
School <10,000 m ² AGA	0.47	0.47	0.47	0.47	0.33
Hospitality > 10,000 m ² AGA	0.20	0.20	0.20	0.20	0.20

Table 4-5 Roof Assembly U-factor ($W/m^2.K$) Requirements for ECBC+ Compliant Building

	Composite	Hot and dry	Warm and humid	Temperate	Cold
Hospitality, Healthcare Assembly	0.20	0.20	0.20	0.20	0.20
Business Educational Shopping Complex	0.26	0.26	0.26	0.26	0.20

Table 4-6 Roof Assembly U-factor ($W/m^2.K$) Requirements for SuperECBC Building

	Composite	Hot and dry	Warm and humid	Temperate	Cold
All buildings types	0.20	0.20	0.20	0.20	0.20

4.3.1.1 Vegetated and Cool Roof

All roofs that are not covered by solar photovoltaics, or solar hot water, or any other renewable energy system, or utilities and services that render it unsuitable for the purpose, shall be either cool roofs or vegetated roofs.

- (a) For qualifying as a cool roof, roofs with slopes less than 20° shall have an initial solar reflectance of no less than 0.60 and an initial emittance no less than 0.90. Solar reflectance shall be determined in accordance with ASTM E903-96 and emittance shall be determined in accordance with ASTM E408-71 (RA 1996).
- (b) For qualifying as a vegetated roof, roof areas shall be covered by living vegetation

4.3.2 Opaque External Wall

Opaque above grade external walls shall comply with the maximum assembly U-factors in Table 4-7 through Table 4-9.

Table 4-7 Opaque Assembly Maximum U-factor ($W/m^2.K$) Requirements for a ECBC compliant Building

	Composite	Hot and dry	Warm and humid	Temperate	Cold
All building types, except below	0.40	0.40	0.40	0.55	0.34
No Star Hotel < 10,000 m ² AGA	0.63	0.63	0.63	0.63	0.40
Business < 10,000 m ² AGA	0.63	0.63	0.63	0.63	0.40
School <10,000 m ² AGA	0.85	0.85	0.85	1.00	0.40

Table 4-8 Opaque Assembly Maximum U-factor ($W/m^2.K$) Requirements for ECBC+ Compliant Building

	Composite	Hot and dry	Warm and humid	Temperate	Cold
All building types, except below	0.34	0.34	0.34	0.55	0.22
No Star Hotel < 10,000 m ² AGA	0.44	0.44	0.44	0.44	0.34
Business < 10,000 m ² AGA	0.44	0.44	0.44	0.55	0.34
School <10,000 m ² AGA	0.63	0.63	0.63	0.75	0.44

Table 4-9 Opaque Assembly Maximum U-factor ($W/m^2.K$) Requirements for SuperECBC Building

	Composite	Hot and dry	Warm and humid	Temperate	Cold
All building types	0.22	0.22	0.22	0.22	0.22

Exceptions to §4.3.1.1: Opaque external walls of an unconditioned building of No Star Hotel, Healthcare, and School categories in all climatic zones, except for cold climatic zone, shall have a maximum assembly U-factor of 0.8 $W/m^2.K$.

4.3.3 Vertical Fenestration

For all climatic zones, vertical fenestration compliance requirements for all three incremental energy efficiency levels, i.e. ECBC, ECBC+, and SuperECBC, shall comply with the following:

- (a) Maximum allowable Window Wall Ratio (WWR) is 40% (applicable to buildings showing compliance using the Prescriptive Method, including Building Envelope Trade-off Method)
- (b) Minimum allowable Visual Light Transmittance (VLT) is 0.27

- (c) Assembly U-factor includes both frame and glass area weighted U-factors
- (d) Assembly SHGC includes both frame and glass area weighted SHGC

Vertical fenestration shall comply with the maximum Solar Heat Gain Coefficient (SHGC) and U-factor requirements of Table 4-10. Vertical fenestration on non-cardinal direction, shall be categorized under a particular cardinal direction if its orientation is within $\pm 22.5^\circ$ of that cardinal direction.

Table 4-10 Vertical Fenestration Assembly U-factor and SHGC Requirements for ECBC Buildings

	Composite	Hot and dry	Warm and humid	Temperate	Cold
Maximum U-factor (W/m ² .K)	3.00	3.00	3.00	3.00	3.00
Maximum SHGC Non-North	0.27	0.27	0.27	0.27	0.62
Maximum SHGC North for latitude $\geq 15^\circ\text{N}$	0.50	0.50	0.50	0.50	0.62
Maximum SHGC North for latitude $< 15^\circ\text{N}$	0.27	0.27	0.27	0.27	0.62
See Appendix A for default values of unrated fenestration.					

Table 4-11 Vertical Fenestration U-factor and SHGC Requirements for ECBC+ buildings and SuperECBC buildings

	Composite	Hot and dry	Warm and humid	Temperate	Cold
Maximum U-factor (W/m ² .K)	2.20	2.20	2.20	3.00	1.80
Maximum SHGC Non-North	0.25	0.25	0.25	0.25	0.62
Maximum SHGC North for latitude $\geq 15^\circ\text{N}$	0.50	0.50	0.50	0.50	0.62
Maximum SHGC North for latitude $< 15^\circ\text{N}$	0.25	0.25	0.25	0.25	0.62

Exceptions to SHGC requirements in Table 4-10 above:

For fenestration with a permanent external projection, including but not limited to overhangs, side fins, box frame, verandah, balcony, and fixed canopies that provide permanent shading to the fenestration, the equivalent SHGC for the proposed shaded fenestration may be determined as less than or equal to the SHGC requirements of Table 4-10. Equivalent SHGC shall be calculated by following the steps listed below:

- Projection factor (PF) for the external permanent projection, shall be calculated as per the applicable shading type listed in §8.2. The range of projection factor for using the SEF is $0.25 \leq PF \leq 1.0$. Other shading devices shall be modeled through the Whole Building Performance Method in §9.
- A shaded vertical fenestration on a non-cardinal direction, shall be categorized either under a particular cardinal direction or a primary inter-cardinal direction if its orientation is within the range of ± 22.5 degrees of the cardinal or primary inter-cardinal direction.
- An equivalent SHGC is calculated by dividing the SHGC of the unshaded fenestration product with a Shading Equivalent Factor (SEF). SEF shall be determined for each orientation and shading device type as per Equation 4.1.
- The maximum allowable SHGC is calculated by multiplying the prescriptive SHGC requirement from Table 4-10 with the SEF.

$$\text{Equation 4.1: } \mathbf{SEF} = (C_3 \times PF^3) + (C_2 \times PF^2) + (C_1 \times PF) + C_0$$

Where,

$$0.25 \leq PF \leq 1.0, \text{ and,}$$

C_3 , C_2 , C_1 and C_0 are the coefficient of shading equivalent factor (SEF), listed in Table 4-12 and Table 4-13.

Table 4-12 Coefficients of Shading Equivalent Factors for Latitudes greater than or equal to 15°N

Coefficients	Overhang + Fin				Overhang				Fin*			
	C3	C2	C1	C0	C3	C2	C1	C0	C3	C2	C1	C0
North	-0.03	-0.23	1.09	0.99	-0.02	-0.10	0.43	0.99	0.14	-0.39	0.62	0.99
East	4.49	-6.35	4.70	0.52	-0.05	0.42	0.66	1.02	0.12	-0.35	0.57	0.99
South	-4.09	8.14	-0.73	1.32	-1.01	1.91	0.24	1.12	0.53	-1.35	1.48	0.88
West	-1.21	3.92	-0.56	1.28	1.52	-2.51	2.30	0.76	0.02	-0.15	0.46	1.01
North-East	-0.95	1.50	0.84	1.18	2.19	-3.78	2.62	0.72	-1.64	3.07	-1.05	1.30
South-East	2.67	-4.99	5.68	0.32	-0.93	1.37	0.76	0.99	0.68	-1.47	1.35	0.88
South-West	-0.50	1.36	2.45	0.73	-3.23	5.61	-1.56	1.32	1.86	-3.81	2.71	0.69
North-West	-6.85	11.7	-3.92	1.89	-0.22	0.19	0.74	1.01	-2.02	2.63	-0.18	1.14

* Coefficients are for side fins on both sides of fenestration. For side fins on only one side, divide the coefficients mentioned in this table by 2.

Table 4-13 Coefficients of Shading Equivalent Factors for Latitudes less than 15°N

Coefficients	Overhang + Fin				Overhang				Fin*			
	C3	C2	C1	C0	C3	C2	C1	C0	C3	C2	C1	C0
North	-0.09	-0.29	1.41	1.05	-0.05	-0.10	0.54	1.02	0.10	-0.40	0.77	1.01
East	-0.55	0.89	1.28	0.97	-0.62	0.88	0.51	1.02	0.15	-0.41	0.56	0.98
South	-4.09	6.98	-1.92	1.41	-2.49	4.89	-2.45	1.43	1.57	-3.35	2.62	0.59
West	-1.99	3.82	-0.19	1.18	-0.16	0.10	0.89	0.97	0.06	-0.22	0.48	0.99
North-East	-1.73	3.45	-0.02	1.23	0.10	-0.55	1.15	0.92	-0.26	0.30	0.48	1.02
South-East	-2.06	4.32	-0.96	1.41	-0.60	0.90	0.37	0.94	0.83	-1.42	1.22	0.92
South-West	-2.06	4.48	-1.13	1.40	-0.39	0.50	0.60	0.87	1.56	-3.17	2.41	0.73
North-West	-0.53	0.72	1.79	0.93	0.10	-0.38	0.96	0.96	0.24	-0.57	0.90	0.97

* Coefficients are for side fins on both sides of fenestration. For side fins on only one side, divide the coefficients mentioned in this table by 2.

- (e) The maximum allowable SHGC of glazing shall be 0.9.
- (f) Any surrounding man-made or natural sunlight obstructers shall be considered as a permanent shading of PF equal to 0.4 if
 - i. the distance between the vertical fenestration of the building, for which compliance is shown, and surrounding man-made or natural sunlight obstructers is less than or equal to twice the height of the surrounding man-made or natural sunlight obstructers; and
 - ii. the surrounding man-made or natural sunlight obstructers shade the façade for at least 80% of the total time that the façade is exposed to direct sun light on a summer solstice. Compliance shall be shown using a sun path diagram for summer solstice super-imposed on the building plan.
- (g) Vertical fenestration, located such that its bottom is more than 2.2 m above the level of the floor, is exempt from the SHGC requirements in Table 4-10, if the following conditions are complied with:
 - i. The Total Effective Aperture for the elevation is less than 0.25, including all fenestration areas more than 1.0 meter above the floor level; and,
 - ii. An interior light shelf is provided at the bottom of this fenestration area, with a projection factor on interior side not less than:
 - a. for E-W, SE, SW, NE, and NW orientations
 - b. 0.5 for S orientation, and
 - c. 0.35 for N orientation when latitude is less than 15°N.



A 5,400 m² two story office building in Delhi is trying to achieve ECBC level compliance. It has a rectangular layout (90 m x 30 m) with floor to floor height of 4.0 m and floor area is evenly distributed over the two floors. Windows are either east or west facing and equally distributed on the two floors. The windows are all 1.85m in length and 2.165m in height with an overhang of 0.85 m. Cill level is 1.385 m above floor level. The overall glazing area is 384 m². SHGC of the glazing in the East/West Fenestration is 0.30; area weighted U-Factor is 3.0 W/m².K. VLT of the glazing in all orientation is 0.5. Will the vertical fenestration comply with the ECBC from the prescriptive approach?

Solution:

Table 4-10 and §4.3.3 lists the U-factor, SHGC and VLT requirements for vertical fenestration for ECBC compliant buildings. The building is located in Delhi (Latitude: 28°70' N, Longitude: 77°10'E), which falls under the composite climate, as per Appendix B, Table 12.1. To fulfil prescriptive requirements, Window to Wall ratio ≤ 40%, SHGC ≤ 0.27, U-factor ≤ 3.0 W/m².K, and VLT ≥ 0.27.

Total Floor area = 5400 m²

Total wall area = 2 x (2x ((90m x 4m) + (30m x 4m))) = 1,920 m²

Total Fenestration area = 384 m²

Window to Wall Ratio (WWR) = 384/1,920 = 20%

As per the calculations, the building has a WWR of 20%, thus complying with the requirement for WWR. The U-factor is also less than 3.0 W/m².K. Similarly the VLT is 0.45, which is greater than the minimum specified value of 0.27, thus complying with the u-factor and VLT requirement.

Equivalent SHGC Calculation

As the windows have an overhang, this case will fall under the exception, and the *equivalent SHGC* value will be calculated as per *Equation 4.1*, i.e.

$$SEF = (C_3 \times PF^3) + (C_2 \times PF^2) + (C_1 \times PF) + C_0$$

Where,

PF= Projection Factor, and,

C₀, C₁, C₂, C₃ are coefficients of Shading Equivalent Factors (SEF), listed in Table 4-12 and Table 4-13.

First, calculate Projection Factor (PF) for each orientation. Shading Equivalent Factor coefficients should be from Table 4-12, as the latitude is greater than 15°N.

$$SEF_{East} = (C_3 \times PF^3) + (C_2 \times PF^2) + (C_1 \times PF) + C_0$$

$$SEF_{East} = (-0.05 \times (0.345)^3) + (0.42 \times (0.345)^2) + (0.66 \times 0.345) + 1.02$$

$$SEF_{East} = 1.296$$

Therefore, equivalent SHGC_{East} = 0.3 ÷ 1.296 = 0.23 Hence the vertical fenestration on the east façade will comply as per prescriptive approach, as the equivalent SHGC is less than maximum allowed.

Similarly, for the west façade:

$$SEF_{\text{west}} = (C_3 \times PF^3) + (C_2 \times PF^2) + (C_1 \times PF) + C_0$$

$$SEF_{\text{west}} = (1.52 \times 0.345^3) + (-2.51 \times 0.345^2) + (2.30 \times 0.345) + 0.76$$

$$SEF_{\text{west}} = 1.317$$

Therefore equivalent $SHGC_{\text{west}} = 0.3 \div 1.317 = 0.23$, hence the vertical fenestration on the west façade will comply using the prescriptive approach, as the equivalent SHGC is less than maximum allowed.

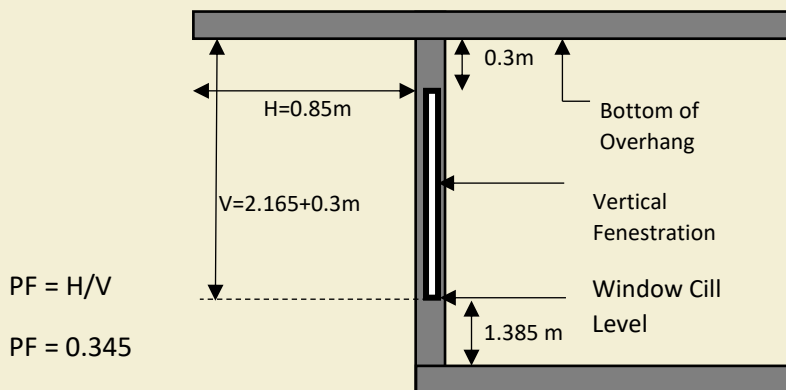

4.3.3.1 U-factor Exception

Vertical fenestration on all unconditioned buildings or unconditioned spaces may have a maximum U-factor of 5 W/m².K provided they comply with all conditions mentioned in Table 4-14.

Table 4-14 U-factor (W/m².K) Exemption Requirements for Shaded Building

Building Type	Climate zone	Orientation	Maximum Effective SHGC	Minimum VLT	PF
Unconditioned buildings or unconditioned spaces	All except cold	Non-North for all latitudes and North for latitude < 15°N	0.27	0.27	≥0.40
		North for latitude > 15°N	0.27	0.27	0.0

4.3.4 Skylights

Skylights shall comply with the maximum U-factor and maximum SHGC requirements of Table 4-15. Skylight roof ratio (SRR), defined as the ratio of the total skylight area of the roof, measured to the outside of the frame, to the gross exterior roof area, is limited to a maximum of 5% for ECBC Building, ECBC+ Building, and SuperECBC Building, when using the Prescriptive Method for compliance.

Table 4-15 Skylight U-factor and SHGC Requirements (U-factor in W/m².K)

Climate	Maximum U-factor	Maximum SHGC
All climatic zones	4.25	0.35

Exception to §4.3.4 Skylights in temporary roof coverings or awnings over unconditioned spaces.

4.3.5 Building Envelope Trade-Off Method

The building envelope complies with the code if the Envelope Performance Factor (EPF) of the Proposed Building is less than the EPF of the Standard Building, where the Standard Building exactly complies with the prescriptive requirements of building envelope. This method shall not be used for buildings with WWR>40%. Trade-off is not permitted for skylights. Skylights shall meet requirements of 4.3.4. The envelope performance factor shall be calculated using the following equations.

Equation 4.2: $EPF_{Total} = EPF_{Roof} + EPF_{Wall} + EPF_{Fenest}$

$$EPF_{Roof} = c_{Roof} \sum_{s=1}^n U_s A_s$$

$$EPF_{Wall} = c_{Wall,Mass} \sum_{s=1}^n U_s A_s + c_{Wall,Other} \sum_{s=1}^n U_s A_s$$

$$EPF_{Fenest} = c_{1Fenest,North} \sum_{w=1}^n U_w A_w + c_{2Fenest,North} \sum_{w=1}^n \frac{SHGC_w}{SEF_w} A_w$$

$$+ c_{1Fenest,South} \sum_{w=1}^n U_w A_w + c_{2Fenest,South} \sum_{w=1}^n \frac{SHGC_w}{SEF_w} A_w$$

$$+ c_{1Fenest,East} \sum_{w=1}^n U_w A_w + c_{2Fenest,East} \sum_{w=1}^n \frac{SHGC_w}{SEF_w} A_w$$

$$+ c_{1Fenest,West} \sum_{w=1}^n U_w A_w + c_{2Fenest,West} \sum_{w=1}^n \frac{SHGC_w}{SEF_w} A_w$$

- EPF_{Roof} Envelope performance factor for roofs. Other subscripts include walls and fenestration.
- A_s, A_w The area of a specific envelope component referenced by the subscript "s" or for windows the subscript "w".
- $SHGC_w$ The solar heat gain coefficient for windows (w).
- SEF_w A multiplier for the window SHGC that depends on the projection factor of an overhang or side fin.
- U_s The U-factor for the envelope component referenced by the subscript "s".
- c_{Roof} A coefficient for the "Roof" class of construction.
- c_{Wall} A coefficient for the "Wall"
- $c_{1Fenest}$ A coefficient for the "Fenestration U-factor"
- $c_{2Fenest}$ A coefficient for the "Fenestration SHGC"

Values of "c" are taken from Table 4-16 through Table 4-20 for each class of construction.

Table 4-16 Envelope Performance Factor Coefficients – Composite Climate

	<i>Daytime Business, Educational, Shopping Complex</i>		<i>24-hour Business, Hospitality, Health Care, Assembly</i>	
	C factor	U-factor	C factor	SHGC
Mass Walls	5.39	-	7.91	-
Curtain Walls, Other	7.83	-	10.32	-
Roofs	14.93	-	17.88	-
North Windows	0.33	81.08	-2.83	119.14
South Windows	-2.30	221.07	-3.54	294.00
East Windows	-1.17	182.64	-3.23	255.91
West Windows	-0.74	182.11	-2.85	252.61

Table 4-17 Envelope Performance Factor Coefficients – Hot and Dry Climate

	<i>Daytime Business, Educational, Shopping Complex</i>		<i>24-hour Business, Hospitality, Health Care, Assembly</i>	
	C factor	U-factor	C factor	SHGC
Mass Walls	6.4	-	12.09	-
Curtain Walls, Other	9.58	-	12.30	-
Roofs	14.82	-	21.12	-
North Windows	-0.37	101.66	0.13	136.80
South Windows	-1.35	252.90	-0.21	327.51
East Windows	-0.85	219.91	-0.16	293.19
West Windows	-0.80	226.57	0.15	300.80

Table 4-18 Envelope Performance Factor Coefficients – Hot Humid Climate

	<i>Daytime Business, Educational, Shopping Complex</i>		<i>24-hour Business, Hospitality, Health Care, Assembly</i>	
	C factor	U-factor	C factor	SHGC
Mass Walls	4.91	-	9.66	-
Curtain Walls, Other	7.98	-	13.32	-
Roofs	13.15	-	19.38	-
North Windows	-1.87	102.83	-3.26	135.84
South Windows	-2.62	218.31	-3.54	277.61
East Windows	-2.07	182.40	-3.37	238.68
West Windows	-2.22	184.75	-3.16	235.95

Table 4-19 Envelope Performance Factor Coefficients – Temperate Climate

	<i>Daytime Business, Educational, Shopping Complex</i>		<i>24-hour Business, Hospitality, Health Care, Assembly</i>	
	C factor U-factor	C factor SHGC	C factor U-factor	C factor SHGC
Mass Walls	2.35	-	5.06	-
Curtain Walls, Other	4.50	-	7.29	-
Roofs	11.78	-	15.15	-
North Windows	-4.17	106.23	-5.58	123.43
South Windows	-4.66	193.63	-5.90	233.84
East Windows	-4.46	211.50	-5.87	267.49
West Windows	-4.67	215.20	-5.33	262.27

Table 4-20 Envelope Performance Factor Coefficients – Cold Climate

	<i>Daytime Business, Educational, Shopping Complex</i>		<i>24-hour Business, Hospitality, Health Care, Assembly</i>	
	C factor U-factor	C factor SHGC	C factor U-factor	C factor SHGC
Mass Walls	17.65	-	12.10	-
Curtain Walls, Other	14.36	-	17.65	-
Roofs	5.79	-	16.02	-
North Windows	-2.40	0.32	8.23	50.36
South Windows	-2.65	-18.75	0.08	172.87
East Windows	-2.78	-16.67	3.83	168.83
West Windows	-2.84	-15.53	5.60	159.43

4.3.6 Standard Building EPF Calculation

EPF of the Standard Building shall be calculated as follows:

- (a) The Standard Building shall have the same building floor area, gross wall area and gross roof area as the Proposed Building. If the building has both 24-hour and daytime occupancies, the distribution between these shall be the same as the Proposed Design.
- (b) The U-factor of each envelope component shall be equal to the criteria from §4 for each class of construction.
- (c) The SHGC of each window shall be equal to the criteria from §4.3.3.



Application of Building Envelope Trade-off method

A 1,000 m² single story daytime use office building in Ahmedabad is trying to achieve ECBC level compliance. Each side has a band of windows, without shading. The materials for the envelope have already been selected, prior to opting for ECBC compliance. Their thermal properties are: roof assembly U-value = .4 W/m².K, external wall assembly U-value = .25 W/m².K, glazing SHGC = .25, VLT = 0.27, area weighted U-value for glazing = 1.8 W/m².K.

External walls are mass wall construction type. Dimensions of the building envelope are as follows:

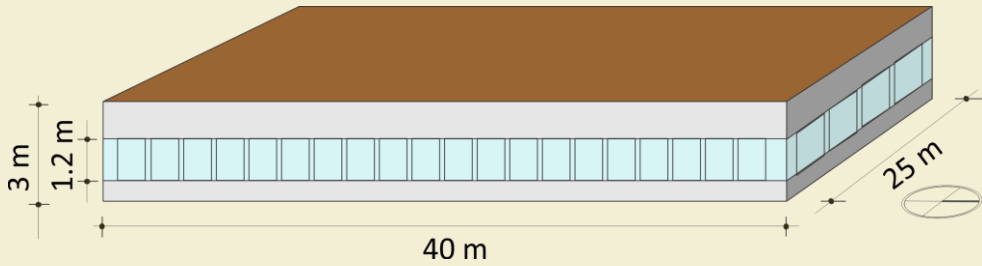

According to Table 11-1, Appendix B, Ahmedabad falls under the hot and dry climate zone. To prove compliance through the prescriptive approach, U values, and SHGC must comply with requirements listed in Table 4-4, Table 4-7, Table 4-10 and VLT and window to wall ratio with requirements in § 4.3.3 for a 24-hour use building in the hot and dry climate zone. The table below lists thermal properties of the building envelope components and the corresponding prescriptive requirements for ECBC complaint buildings.

Table 4-3-1 Prescriptive Requirements and Proposed Thermal Properties

	<i>Prescriptive U-factor</i>			<i>Proposed U-factor</i>			<i>Area</i>
	<i>(W/m².K)</i>			<i>(W/m².K)</i>			<i>(m²)</i>
Wall 1– North, South	=<0.63			0.25			90
Wall 2– East, West	=<0.63			0.25			144
Roof	=<0.33			0.4			1000
	<i>U-factor</i>	<i>SHGC</i>	<i>VLT</i>	<i>U-factor</i>	<i>SHGC</i>	<i>VLT</i>	
Window – South	=<3.0	=<0.27	=<0.27	1.8	0.25	0.27	30
Window – North	=<3.0	=<0.5	=<0.27	1.8	0.25	0.27	30
Window-East	=<3.0	=<0.27	=<0.27	1.8	0.25	0.27	48
Window-West	=<3.3	=<0.27	=<0.27	1.8	0.25	0.27	48

U-value of the roof of the proposed building, at 0.4 W/m².K does not fulfil prescriptive requirements. Similarly, §4.3.3 requires the WWR to be less than 40%. This condition is fulfilled in the proposed buildings as can be seen in the calculations below.

$$\text{Total Fenestration Area}_{\text{North, South}} = 2 \times (25\text{m} \times 1.2\text{m}) = 60 \text{ m}^2$$

$$\text{Wall Area}_{\text{North, South}} = 2 \times (25\text{m} \times 3\text{m}) = 150 \text{ m}^2$$

$$\text{Total Fenestration Area}_{\text{East, West}} = 2 \times (40\text{m} \times 1.2\text{m}) = 96 \text{ m}^2$$

$$\text{Total Wall Area}_{\text{East, West}} = 2 \times (40\text{m} \times 3\text{m}) = 240 \text{ m}^2$$

$$\text{Total Fenestration Area} = 156 \text{ m}^2, \text{ Total Wall Area} = 390 \text{ m}^2$$

$$\text{WWR} = 156/390 = 0.4.$$

Hence, this building will not be compliant if the prescriptive approach is followed.

Compliance through Building Envelope Trade-off method

Envelope performance factor (EPF) for the Standard Building and Proposed Building must be compared. As per the Building Envelope Trade-off method, the envelope performance factor (EPF) shall be calculated using the following equations:

$$\text{Equation 11.1 } EPF_{\text{Total}} = EPF_{\text{Roof}} + EPF_{\text{Wall}} + EPF_{\text{Fenest}}$$

Where,

$$EPF_{\text{Roof}} = C_{\text{Roof}} \sum_{s=1}^n U_s A_s$$

$$EPF_{\text{Wall}} = C_{\text{Wall,Mass}} \sum_{s=1}^n U_s A_s + C_{\text{Wall,Other}} \sum_{s=1}^n U_s A_s$$

$$\begin{aligned} EPF_{\text{Fenest}} &= C_{1\text{Fenest,North}} \sum_{w=1}^n U_w A_w + C_{2\text{Fenest,North}} \sum_{w=1}^n \frac{SHGC_w}{SEF_w} A_w \\ &+ C_{1\text{Fenest,South}} \sum_{w=1}^n U_w A_w + C_{2\text{Fenest,South}} \sum_{w=1}^n \frac{SHGC_w}{SEF_w} A_w \\ &+ C_{1\text{Fenest,East}} \sum_{w=1}^n U_w A_w + C_{2\text{Fenest,East}} \sum_{w=1}^n \frac{SHGC_w}{SEF_w} A_w \\ &+ C_{1\text{Fenest,West}} \sum_{w=1}^n U_w A_w + C_{2\text{Fenest,West}} \sum_{w=1}^n \frac{SHGC_w}{SEF_w} A_w \end{aligned}$$

Standard Building EPF will be derived from U-factors, SHGCs and VLTs of walls, roofs and fenestration from Table 4-4, Table 4-7, Table 4-10 and § 4.3.3 for a 24-hour use building in the hot and dry climate zone. Values of C are from 24-hour Office building in hot and dry climatic zone for each class of construction from Table 4-16. Since There is no shading for the windows, M_w will not be considered.

Step 1: Calculation of EPF Proposed Building from actual envelope properties

$$EPF_{Roof,Actual} = C_{Roof} \sum_{s=1}^n U_s A_s$$
$$= 14.82 \times 0.40 \times 1,000 = 5,928$$

$$EPF_{Wall,Actual} = C_{Wall,Mass} \sum_{s=1}^n U_s A_s + C_{Wall,Other} \sum_{s=1}^n U_s A_s$$
$$= (6.4 \times 0.25 \times 90) + (6.4 \times 0.25 \times 144) = 374.4$$

$$EPF_{Fenest} = EPF_{Fenest, North} + EPF_{Fenest, South} + EPF_{Fenest, East} + EPF_{Fenest, West}$$

$$EPF_{Fenest} = C_{1Fenest} \sum_{w=1}^n U_w A_w + C_{2Fenest} \sum_{w=1}^n \frac{SHGC_w}{SEF_w} A_w$$

Hence,

$$EPF_{Fenest, North} = -0.37 \times 1.8 \times 30 + 101.66 \times 0.25 \times 30 = -19.98 + 762.45 = 742.47$$

$$EPF_{Fenest, South} = -1.35 \times 1.8 \times 30 + 252.90 \times 0.25 \times 30 = -72.9 + 1,896.75 = 1,823.85$$

$$EPF_{Fenest, East} = -0.85 \times 1.8 \times 48 + 219.91 \times 0.25 \times 48 = -73.44 + 2,638.9 = 2,565.46$$

$$EPF_{Fenest, West} = -0.80 \times 1.8 \times 48 + 226.57 \times 0.25 \times 48 = -69.12 + 2,718.8 = 2,649.7$$

Therefore,

$$EPF_{Fenest} = 7,781.5$$

$$EPF_{Proposed} = 5,928 + 374.4 + 7,781.5 = 14,083.9$$

Step 2: Calculating EPF Standard Building from prescriptive envelope requirements

$$EPF_{Roof,Actual} = C_{Roof} \sum_{s=1}^n U_s A_s$$
$$= 14.82 \times 0.33 \times 1000 = 4,890.6$$

$$EPF_{Wall,Actual} = C_{Wall,Mass} \sum_{s=1}^n U_s A_s + C_{Wall,Other} \sum_{s=1}^n U_s A_s$$
$$= (6.4 \times 0.63 \times 90) + (6.4 \times 0.63 \times 144) = 362.88 + 580.6 = 943.5$$

$$EPF_{Fenest} = EPF_{Fenest, North} + EPF_{Fenest, South} + EPF_{Fenest, East} + EPF_{Fenest, West}$$

Now,

$$EPF_{Fenest, North} = -0.37 \times 3.3 \times 30 + 101.66 \times 0.5 \times 30 = -36.63 + 1,524.9 = 1,488.3$$

$$EPF_{Fenest, South} = -1.35 \times 3.3 \times 30 + 252.9 \times 0.27 \times 30 = -133.7 + 2,048.5 = 1,914.8$$

$$EPF_{Fenest, East} = -0.85 \times 3.3 \times 48 + 219.91 \times 0.27 \times 48 = -134.64 + 2,850 = 2,715.4$$

$$EPF_{Fenest, West} = -0.8 \times 3.3 \times 48 + 226.57 \times 0.27 \times 48 = -126.7 + 2,936 = 2,809.6$$

Therefore, $EPF_{Fenest} = 8,928$

$$EPF_{Baseline} = 4,890.6 + 943.5 + 8,928 = 14,762.2$$

Since $EPF_{Baseline} > EPF_{Proposed}$, therefore the building is compliant with ECBC building envelope requirements.

5 Comfort Systems & Controls

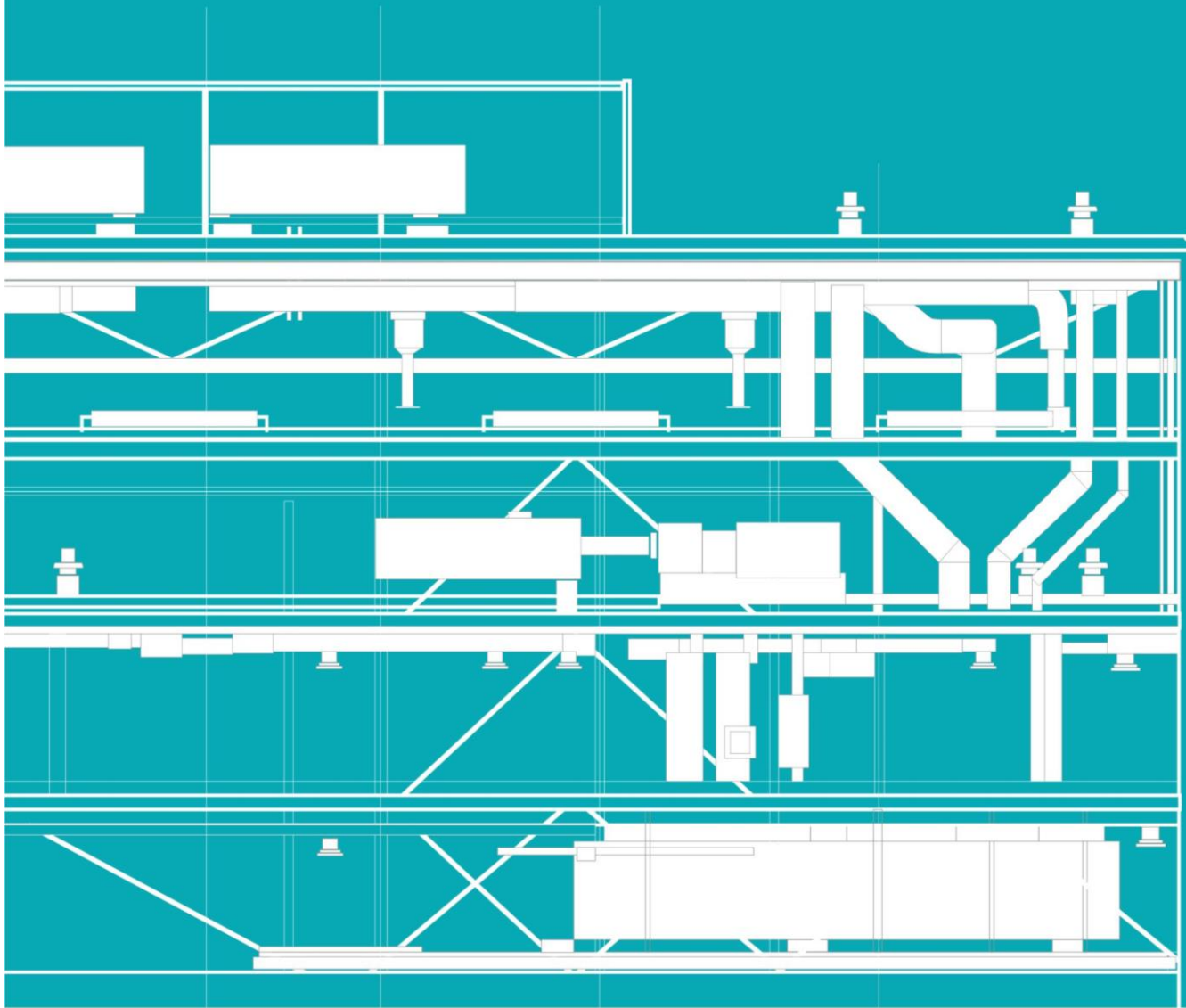

5. Comfort Systems and Controls

5.1 General

All heating, ventilation, air conditioning equipment and systems, and their controls shall comply with the mandatory provisions of §5.2 and the prescriptive criteria of §5.3 for the respective building energy efficiency level.

All service water heating equipment and systems shall comply with the mandatory provisions of §5.2.

5.2 Mandatory Requirements

5.2.1 Ventilation

- (a) All habitable spaces shall be ventilated with outdoor air in accordance with the requirements of §5.2.1 and guidelines specified in the National Building Code 2016 (Part 8: Building Services, Section 1: Lighting and Natural Ventilation, Subsection 5: Ventilation).
- (b) Ventilated spaces shall be provided with outdoor air using one of the following:
 - i. Natural ventilation
 - ii. Mechanical ventilation
 - iii. Mixed mode ventilation

5.2.1.1 Natural Ventilation Design Requirements

Naturally ventilated buildings or spaces in a mixed-mode ventilated buildings shall:

- (a) Comply with guidelines provided for natural ventilation in NBC.
- (b) Have minimum BEE 3-star rated ceiling fans, if provided with ceiling fans.
- (c) Have exhaust fans complying with minimum efficiency requirements of fans in §5.3, if provided.

5.2.1.2 Mechanical Ventilation Air Quantity Design Requirements

Buildings that are ventilated using a mechanical ventilation system or spaces in mixed-mode ventilated buildings that are ventilated with a mechanical system, either completely or in conjunction with natural ventilation systems, shall:

- (a) Install mechanical systems that provide outdoor air change rate as per NBC.
- (b) Have a ventilation system controlled by CO sensors for basement carpark spaces with total car park space greater than or equal to 600 m².



Human body has the ability to adapt to environmental conditions and become accustomed to them over time. People accustomed to the variability of environmental parameters in non-air-conditioned buildings can live and work through a larger temperature range without experiencing thermal discomfort. This logic informs the adaptive thermal comfort model for buildings. Adaptive comfort models offer an opportunity to reduce energy use as buildings can be operated at more moderate temperatures. Energy used to maintain stringent comfort conditions through mechanical equipment can thus be avoided. Operative temperatures for the model can be calculated using the formulae below.

Naturally Ventilated Buildings

$$\text{Indoor Operative Temperature} = (0.54 \times \text{outdoor temperature}) + 12.83$$

Where, indoor operative temperature (°C) is neutral temperature, & outdoor temperature is the 30-day outdoor running mean air temperature (°C).

The 90 % acceptability range for the India specific adaptive models for naturally ventilated buildings is $\pm 2.38^\circ\text{C}$.

For example, Indoor Operative Temperature for a naturally ventilated building in Delhi
 $= (0.54 \times 33.0) + 12.83 = \underline{30.68^\circ\text{C}}$

Mixed Mode Buildings

$$\text{Indoor Operative Temperature} = (0.28 \times \text{outdoor temperature}) + 17.87$$

Where indoor operative temperature (°C) is neutral temperature & outdoor temperature is the 30-day outdoor running mean air temperature (°C).

The 90% acceptability range for the India specific adaptive models for mixed-mode buildings is $\pm 3.46^\circ\text{C}$.

For example, Indoor Operative Temperature for a mixed mode building in Delhi
 $= (0.28 \times 33.0) + 17.87 = \underline{27.1^\circ\text{C}}$

Air Conditioned Buildings

$$\text{Indoor Operative Temperature} = (0.078 \times \text{outdoor temperature}) + 23.25$$

Where indoor operative temperature (°C) is neutral temperature & outdoor temperature is the 30-day outdoor running mean air temperature (°C).

The 90% acceptability range for the adaptive models for conditioned buildings is $\pm 1.5^\circ\text{C}$.

For example, Indoor Operative Temperature for an air-conditioned building in Delhi
 $= (0.078 \times 33.0) + 23.25$
 $= 25.8^\circ\text{C}$

5.2.1.3 Demand Control Ventilation

Mechanical ventilation systems shall have demand control ventilation if they provide outdoor air greater than 1,500 liters per second, to a space greater than 50 m², with occupant density exceeding 40 people per 100 m² of the space, and are served by one or more of the following systems:

- (a) An air side economizer
- (b) Automatic outdoor modulating control of the outdoor air damper

Exceptions to § 5.2.1.3: Following shall be exempt from installing demand control ventilation systems:

- (a) Classrooms in Schools, call centers category under Business
- (b) Spaces that have processes or operations that generate dust, fumes, mists, vapors, or gases and are provided with exhaust ventilation, such as indoor operation of internal combustion engines or areas designated for unvented food service preparation, or beauty salons
- (c) Systems with exhaust air energy recovering system

5.2.2 Minimum Space Conditioning Equipment Efficiencies

5.2.2.1 Chillers

- (a) Chillers shall meet or exceed the minimum efficiency requirements presented in Table 5-1 through Table 5-2 under ANSI/ AHRI 550/ 590 conditions.
- (b) The application of air-cooled chiller is allowed in all buildings with cooling load less than 530 kW. For buildings with cooling load equal to or greater than 530 kW, the number of air-cooled chiller shall be restricted to 33% of the total installed chilled water capacity unless the authority having jurisdiction mandates the application of air cooled chillers.
- (c) Minimum efficiency requirements under BEE Standards and Labeling Program for chillers shall take precedence over the minimum requirements presented in Table 5-1 through Table 5-2.
- (d) To show compliance to ECBC, minimum requirement of both COP and IPLV requirement of ECBC Building shall be met. To show compliance with ECBC+ Building and SuperECBC Building, minimum requirement of either COP or IPLV of respective efficiency level shall be met.

Table 5-1 Minimum Energy Efficiency Requirements for water cooled Chillers

Chiller Capacity (kW _r)	ECBC Building		ECBC+ Building		SuperECBC Building	
	COP	IPLV	COP	IPLV	COP	IPLV
<260	4.7	5.8	5.2	6.9	5.8	7.1
≥260 & <530	4.9	5.9	5.8	7.1	6.0	7.9
≥530 & <1,050	5.4	6.5	5.8	7.5	6.3	8.4
≥1,050 & <1,580	5.8	6.8	6.2	8.1	6.5	8.8
≥1,580	6.3	7.0	6.5	8.9	6.7	9.1

Table 5-2 Minimum Energy Efficiency Requirements for air cooled Chillers

Chiller Capacity (kW _r)	ECBC Building		ECBC+ Building		SuperECBC Building
	COP	IPLV	COP	IPLV	COP/ IPLV
<260	2.8	3.5	3.0	4.0	NA
≥260	3.0	3.7	3.2	5.0	NA

5.2.2.2 Unitary, Split, Packaged Air-Conditioners

Unitary air-conditioners shall meet or exceed the efficiency requirements given in

Table 5-3 through Table 5-5. Window and split air conditioners shall be certified under BEE's Star Labeling Program. EER shall be as per IS 8148 for all unitary, split, packaged air conditioners greater than 10 kW_r.

Table 5-3 Minimum Requirements for Unitary, Split, Packaged Air Conditioners in ECBC Building

Cooling Capacity (kW _r)	Water Cooled	Air Cooled
≤ 10.5	NA	BEE 3 Star
> 10.5	3.3 EER	2.8 EER

Table 5-4 Minimum Requirements for Unitary, Split, Packaged Air Conditioners in ECBC+ Building

Cooling Capacity (kW _r)	Water Cooled	Air Cooled
≤ 10.5	NA	BEE 4 Star
> 10.5	3.7 EER	3.2 EER

Table 5-5 Minimum Requirements for Unitary, Split, Packaged Air Conditioners in SuperECBC Building

Cooling Capacity (kW _r)	Water Cooled	Air Cooled
≤ 10.5	NA	BEE 5 Star
>10.5	3.9 EER	3.4 EER

5.2.2.3 Variable Refrigerant Flow

Variable Refrigerant Flow (VRF) systems shall meet or exceed the efficiency requirements specified in Table 5-6 as per the ANSI/AHRI Standard 1230 while the Indian Standard on VRF is being developed. BEE Standards and Labeling requirements for VRF shall take precedence over the current minimum requirement.

Table 5-6 Minimum Efficiency Requirements for VRF Air conditioners for ECBC Building*

Type	Size category (kW _r)	For Heating or cooling or both	
		EER	IEER
VRF Air Conditioners, Air cooled	< 40	3.28	4.36
	>= 40 and < 70	3.26	4.34
	>= 70	3.02	4.07

* The revised EER and IEER values as per Indian Standard for VRF corresponding to values in this table will supersede as and when the revised standards are published.

5.2.2.4 Air Conditioning and Condensing Units Serving Computer Rooms

Air conditioning and condensing units serving computer rooms shall meet or exceed the energy efficiency requirements listed in Table 5-7.

Table 5-7 Minimum Efficiency Requirements for Computer Room Air Conditioners

Equipment type	Net Sensible Cooling Capacity ^a	Minimum SCOP-127 ^b	
		Downflow	Upflow
All types of computer room ACs Air/ Water/ Glycol	All capacity	2.5	2.5

a. Net Sensible cooling capacity = Total gross cooling capacity - latent cooling capacity – Fan power
b. Sensible Coefficient of Performance (SCOP-127): A ratio calculated by dividing the net sensible cooling capacity in watts by the total power input in watts (excluding reheater and dehumidifier) at conditions defined in ASHRAE Standard 127-2012 Method of Testing for Rating Computer and Data Processing Room Unitary Air Conditioners)

5.2.3 Controls

To comply with the Code, buildings shall meet the requirements of §5.2.3.1 through §5.2.3.5.

5.2.3.1 Timeclock

Mechanical cooling and heating systems in Universities and Training Institutions of all sizes and all Shopping Complexes with built up area greater than 20,000 m² shall be controlled by timeclocks that:

- (a) Can start and stop the system under different schedules for three different day-types per week,

- (b) Are capable of retaining programming and time setting during loss of power for a period of at least 10 hours, and
- (c) Include an accessible manual override that allows temporary operation of the system for up to 2 hours.

Exceptions to §5.2.3.1:

- (a) Cooling systems less than 17.5 kW_r
- (b) Heating systems less than 5.0 kW_r
- (c) Unitary systems of all capacities

5.2.3.2 Temperature Controls

Mechanical heating and cooling equipment in all buildings shall be installed with controls to manage the temperature inside the conditioned zones. Each floor or a building block shall be installed with at least one control to manage the temperature. These controls should meet the following requirements:

- (a) Where a unit provides both heating and cooling, controls shall be capable of providing a temperature dead band of 3.0°C within which the supply of heating and cooling energy to the zone is shut off or reduced to a minimum.
- (b) Where separate heating and cooling equipment serve the same temperature zone, temperature controls shall be interlocked to prevent simultaneous heating and cooling.
- (c) Separate thermostat control shall be installed in each
 - i. guest room of Resort and Star Hotel,
 - ii. room less than 30 m² in Business,
 - iii. air-conditioned class room, lecture room, and computer room of Educational,
 - iv. in-patient and out-patient room of Healthcare

5.2.3.3 Occupancy Controls

Occupancy controls shall be installed to de-energize or to throttle to minimum the ventilation and/or air conditioning systems when there are no occupants in:

- (a) Each guest room in a Resort and Star Hotel
- (b) Each public toilet in a Star Hotel or Business with built up area more than 20,000 m²
- (c) Each conference and meeting room in a Star Hotel or Business
- (d) Each room of size more than 30 m² in Educational buildings

5.2.3.4 Fan Controls

Cooling towers in buildings with built up area greater than 20,000 m², shall have fan controls based on wet bulb logic, with either:

- (a) Two speed motors, pony motors, or variable speed drives controlling the fans, or
- (b) Controls capable of reducing the fan speed to at least two third of installed fan power

5.2.3.5 Dampers

All air supply and exhaust equipment, having a Variable Frequency Drive (VFD), shall have dampers that automatically close upon:

- (a) Fan shutdown, or,
- (b) When spaces served are not in use
- (c) Backdraft gravity damper is acceptable in the system with design outdoor air of the system is less than 150 liters per second in all climatic zones except cold climate, provided backdraft dampers for ventilation air intakes are protected from direct exposure to wind.
- (d) Dampers are not required in ventilation or exhaust systems serving naturally conditioned spaces.
- (e) Dampers are not required in exhaust systems serving kitchen exhaust hoods.

5.2.4 Additional Controls for ECBC+ and SuperECBC Buildings

ECBC+ building shall comply with requirements of § 5.2.4 in addition to complying with requirements of §5.2.3.

5.2.4.1 Centralized Demand Shed Controls

ECBC+ and SuperECBC Buildings with built up area greater than 20,000 m² shall have a building management system. All mechanical cooling and heating systems in ECBC+ and SuperECBC Buildings with any programmable logic controller (PLC) to the zone level shall have the following control capabilities to manage centralized demand shed in noncritical zones:

- (a) Automatic demand shed controls that can implement a centralized demand shed in non-critical zones during the demand response period on a demand response signal.
- (b) Controls that can remotely decrease or increase the operating temperature set points by four degrees or more in all noncritical zones on signal from a centralized control point
- (c) Controls that can provide an adjustable rate of change for the temperature setup and reset

The centralized demand shed controls shall have additional capabilities to

- (a) Be disabled by facility operators
- (b) Be manually controlled from a central point by facility operators to manage heating and cooling set points

5.2.4.2 Supply Air Temperature Reset

Multi zone mechanical cooling and heating systems in ECBC+ and SuperECBC Buildings shall have controls that automatically reset the supply-air temperature in response to building loads or to outdoor air temperature. Controls shall reset the supply air temperature to at least 25% of the difference between the design supply air temperature and the design room air temperature.

Exception to § 5.2.4.2 : ECBC+ and SuperECBC Buildings in warm humid climate zone.

5.2.4.3 Chilled Water Temperature Reset

Chilled water systems with a design capacity exceeding 350 kW_r supplying chilled water to comfort conditioning systems in ECBC+ and SuperECBC Buildings shall have controls that automatically reset supply water temperatures by representative building loads (including return water temperature) or by outdoor air temperature.

Exceptions to § 5.2.4.3: Controls to automatically reset chilled water temperature shall not be required where the supply temperature reset controls causes improper operation of equipment.

5.2.5 Additional Controls for SuperECBC Buildings

SuperECBC Buildings shall comply with requirements of § 5.2.5 in addition to complying with requirements of § 5.2.3 and § 5.2.4.

5.2.5.1 Variable Air Volume Fan Control

Fans in Variable Air Volume (VAV) systems in SuperECBC Buildings shall have controls or devices that will result in fan motor demand of no more than 30% of their design wattage at 50% of design airflow based on manufacturer's certified fan data.

5.2.6 Piping and Ductwork

5.2.6.1 Piping Insulation

Piping for heating, space conditioning, and service hot water systems shall meet the insulation requirements listed in Table 5-8 through Table 5-10. Insulation exposed to weather shall be protected by aluminum sheet metal, painted canvas, or plastic cover. Cellular foam insulation shall be protected as above, or be painted with water retardant paint.

Exceptions to § 5.2.6.1:

- (a) Reduction in insulation R value by 0.2 (compared to values in Table 5-8, Table 5-9 and Table 5-10) to a minimum insulation level of R-0.4 shall be permitted for any pipe located in partition within a conditioned space or buried.
- (b) Insulation R value shall be increased by 0.2 over and above the requirement stated in Table 5-8 through Table 5-10 for any pipe located in a partition outside a building with direct exposure to weather.

- (c) Reduction in insulation R value by 0.2 (compared to values in Table 5-8, Table 5-9 and Table 5-10) to a minimum insulation level of R-0.4 shall be permitted for buildings in Temperate climate zone.

Table 5-8 Insulation Requirements for Pipes in ECBC Building

Operating Temperature (°C)	Pipe size (mm)	
	<25	>=40
Insulation R value (m ² .K/W)		
Heating System		
94°C to 121°C	0.9	1.2
60°C to 94°C	0.7	0.7
40°C to 60°C	0.4	0.7
Cooling System		
4.5°C to 15°C	0.4	0.7
< 4.5°C	0.9	1.2
Refrigerant Piping (Split systems)		
4.5°C to 15°C	0.4	0.7
< 4.5°C	0.9	1.2

Table 5-9 Insulation Requirements for Pipes in ECBC+ Building

Operating Temperature (°C)	Pipe size (mm)	
	< 40	>=40
Insulation R value (m ² .K/W)		
Heating System		
94°C to 121°C	1.1	1.3
60°C to 94°C	0.8	0.8
40°C to 60°C	0.5	0.9
Cooling System		
4.5°C to 15°C	0.5	0.9
< 4.5°C	1.1	1.3
Refrigerant Piping (Split Systems)		
4.5°C to 15°C	0.5	0.9
< 4.5°C	1.1	1.3

Table 5-10 Insulation Requirements for Pipes in SuperECBC Buildings

Operating Temperature (°C)	Pipe size (mm)	
	< 40	>=40
	Insulation R value (m ² .K/W)	
Heating System		
94°C to 121°C	1.5	1.5
60°C to 94°C	1.0	1.3
40°C to 60°C	0.7	1.1
Cooling System		
4.5°C to 15°C	0.7	1.2
< 4.5°C	1.5	1.5
Refrigerant Piping (Split Systems)		
4.5°C to 15°C	0.4	0.7
< 4.5°C	1.5	1.5

5.2.6.2 Ductwork and Plenum Insulation

Ductwork and plenum shall be insulated in accordance with Table 5-11.

Table 5-11 Ductwork Insulation (R value in m². K/W) Requirements

Duct Location	Supply ducts	Return ducts
Exterior	R -1.4	R -0.6
Unconditioned Space	R -0.6	None
Buried	R -0.6	None

5.2.7 System Balancing

5.2.7.1 General

System balancing shall be done for systems serving zones with a total conditioned area exceeding 500 m².

5.2.7.2 Air System Balancing

Air systems shall be balanced in a manner to first minimize throttling losses; then, for fans with fan system power greater than 0.75 kW, fan speed shall be adjusted to meet design flow conditions.

5.2.7.3 Hydronic System Balancing

Hydronic systems shall be proportionately balanced in a manner to first minimize throttling losses; then the pump impeller shall be trimmed or pump speed shall be adjusted to meet design flow conditions.

5.2.8 Condensers

5.2.8.1 Condenser Locations

Condensers shall be located such that the heat sink is free of interference from heat discharge by devices located in adjoining spaces, and do not interfere with other such systems installed nearby.

5.2.9 Service Water Heating

5.2.9.1 Solar Water Heating

To comply with the Code, Hotels and Hospitals in all climatic zones and all buildings in cold climate zone with a hot water system, shall have solar water heating equipment installed to provide for:

- (a) at least 20% of the total hot water design capacity if above grade floor area of the building is less than 20,000 m²
- (b) at least 40% of the total hot water design capacity if above grade floor area of the building is greater than or equal to 20,000 m²

For compliance with ECBC+ and SuperECBC, Hotels and Hospitals in all climatic zones and all buildings in cold climate zone with a hot water system, shall have solar water heating equipment installed to provide at least 40% and 60% respectively of the total hot water design capacity.

Exception to § 5.2.9.1: Systems that use heat recovery to provide the hot water capacity required as per the efficiency level or building size.

5.2.9.2 Heating Equipment Efficiency

Service water heating equipment shall meet or exceed the performance and minimum efficiency requirements presented in available Indian Standards

- (a) Solar water heater shall meet the performance/ minimum efficiency level mentioned in IS 13129 Part (1&2)
- (b) Gas Instantaneous water heaters shall meet the performance/minimum efficiency level mentioned in IS 15558 with above 80% Fuel utilization efficiency.
- (f) Electric water heater shall meet the performance/ minimum efficiency level mentioned in IS 2082.

5.2.9.3 Other Water Heating System

Supplementary heating system shall be designed to maximize the energy efficiency of the system and shall incorporate the following design features in cascade:

- (a) Maximum heat recovery from hot discharge system like condensers of air conditioning units,
- (b) Use of gas fired heaters wherever gas is available, and
- (c) Electric heater as last resort.

5.2.9.4 Piping Insulation

Piping insulation shall comply with § 5.2.6.1. The entire hot water system including the storage tanks, pipelines shall be insulated conforming to the relevant IS standards on materials and applications.

5.2.9.5 Heat Traps

Vertical pipe risers serving storage water heaters and storage tanks not having integral heat traps and serving a non-recirculating system shall have heat traps on both the inlet and outlet piping.

5.2.9.6 Swimming Pools

All heated pools shall be provided with a vapor retardant pool cover on or at the water surface. Pools heated to more than 32°C shall have a pool cover with a minimum insulation value of R-4.1.

Exception to § 5.2.9.6: Pools deriving over 60% of their energy from site-recovered energy or solar energy source.

5.3 Prescriptive Requirements

Compliance shall be demonstrated with the prescriptive requirements in this section. Supply, exhaust, and return or relief fans with motor power exceeding 0.37 kW shall meet or exceed the minimum energy efficiency requirements specified in Table 5-12 through Table 5-14 except the following need not comply with the requirement

- (a) Fans in un-ducted air conditioning unit where fan efficiency has already been taken in account to calculate the efficiency standard of the comfort system.
- (b) Fans in Health Care buildings having HEPA filters.
- (c) Fans inbuilt in energy recovery systems that pre-conditions the outdoor air.

Table 5-12 Mechanical and Motor Efficiency Requirements for Fans in ECBC Buildings

System type	Fan Type	Mechanical Efficiency	Motor Efficiency (As per IS 12615)
Air-handling unit	Supply, return and exhaust	60%	IE 2

Table 5-13 Mechanical and Motor Efficiency Requirements for Fans in ECBC+ Buildings

System type	Fan Type	Mechanical Efficiency	Motor Efficiency (As per IS 12615)
Air-handling unit	Supply, return and exhaust	65%	IE 3

Table 5-14 Mechanical and Motor Efficiency Requirements for Fans in SuperECBC Buildings

System Type	Fan Type	Mechanical Efficiency	Motor Efficiency (As per IS 12615)
Air-handling unit	Supply, return and exhaust	70%	IE 4

5.3.1 Pumps

Chilled and condenser water pumps shall meet or exceed the minimum energy efficiency requirements specified in Table 5-15 through Table 5-17. Requirements for pumps in district chiller systems and hot water pumps for space heating are limited to the installed efficiency requirement of individual pump equipment only. To show compliance, calculate the total installed pump capacity in kilo watt and achieve the prescribed limits per kilo watt of refrigeration installed in the building.

Exceptions to § 5.3.1: Pumps used in processes e.g. service hot water, chilled water used for refrigeration etc.

Table 5-15 Pump Efficiency Requirements for ECBC Building

Equipment	ECBC
Chilled Water Pump (Primary and Secondary)	18.2 W/ kW _r with VFD on secondary pump
Condenser Water Pump	17.7 W/ kW _r
Pump Efficiency (minimum)	70%

Table 5-16 Pump Efficiency Requirements for ECBC+ Building

<i>Equipment</i>	<i>ECBC+ Building</i>
Chilled Water Pump (Primary and Secondary)	16.9 W/ kW _r with VFD on secondary pump
Condenser Water Pump	16.5 W/ kW _r
Pump Efficiency (minimum)	75%

Table 5-17 Pump Efficiency Requirements for SuperECBC Building

<i>Equipment</i>	<i>SuperECBC Building</i>
Chilled Water Pump (Primary and Secondary)	14.9 W/ kW _r with VFD on secondary pump
Condenser Water Pump	14.6 W/ kW _r
Pump Efficiency (minimum)	85%

5.3.2 Cooling Towers

Cooling towers shall meet or exceed the minimum efficiency requirements specified in Table 5-18. ECBC+ and SuperECBC Buildings shall have additional VFD installed in the cooling towers.

Table 5-18 Cooling Tower Efficiency Requirements for ECBC, ECBC+, and SuperECBC Buildings

<i>Equipment type</i>	<i>Rating Condition</i>	<i>Efficiency</i>
Open circuit cooling tower Fans	35°C entering water	0.017 kW/kW _r
	29°C leaving water	0.31 kW/ L/s
	24°C WB outdoor air	

5.3.3 Economizers

5.3.3.1 Economizer for ECBC, ECBC+, and SuperECBC Building

Each cooling fan system in buildings with built up area greater than 20,000 m², shall include at least one of the following:

- An air economizer capable of modulating outside-air and return-air dampers to supply 50% of the design supply air quantity as outside-air.
- A water economizer capable of providing 50% of the expected system cooling load at outside air temperatures of 10°C dry-bulb/7.2°C wet-bulb and below.

Exception to §5.3.3.1:

- Projects in warm-humid climate zones are exempt.
- Projects with only daytime occupancy in the hot-dry are exempt.
- Individual ceiling mounted fan systems is less than 3,200 liters per second exempt.

5.3.3.2 Partial Cooling

Where required by §5.3.3.1 economizers shall be capable of providing partial cooling even when additional mechanical cooling is required to meet the cooling load.

5.3.3.3 Economizer Controls

Air economizer shall be equipped with controls

- (a) That allow dampers to be sequenced with the mechanical cooling equipment and not be controlled by only mixed air temperature.
- (b) capable of automatically reducing outdoor air intake to the design minimum outdoor air quantity when outdoor air intake will no longer reduce cooling energy usage.
- (c) Capable of high-limit shutoff at 24 °C dry bulb temperature.

5.3.3.4 Testing

Air-side economizers shall be tested in the field following the requirements in §12 Appendix C to ensure proper operation.

Exception to §5.3.3.4: Air economizers installed by the HVAC system equipment manufacturer and certified to the building department as being factory calibrated and tested per the procedures in §12.

5.3.4 Variable Flow Hydronic Systems

5.3.4.1 Variable Fluid Flow

HVAC pumping systems having a total pump system power exceeding 7.5 kW shall be designed for variable fluid flow and shall be capable of reducing pump flow rates to an extent which is lesser or equal to the limit, where the limit is set by the larger of:

- (a) 50% of the design flow rate, or
- (b) the minimum flow required by the equipment manufacturer for proper operation of the chillers or boilers.

5.3.4.2 Isolation Valves

Water cooled air-conditioning or heat pump units with a circulation pump motor greater than or equal to 3.7 kW shall have two-way automatic isolation valves on each water cooled air-conditioning or heat pump unit that are interlocked with the compressor to shut off condenser water flow when the compressor is not operating.

5.3.4.3 Variable Speed Drives

Chilled water or condenser water systems that must comply with either §5.3.4.1 or §5.3.4.2 and that have pump motors greater than or equal to 3.7 kW shall be controlled by variable speed drives.

5.3.5 Boilers

Gas and oil fired boilers shall meet or exceed the minimum efficiency requirements specified in Table 5-19 and Table 5-20.

Table 5-19 Minimum Efficiency Requirements for Oil and Gas Fired Boilers for ECBC building

Equipment Type	Sub Category	Size Category	Minimum FUE
Boilers, Hot Water	Gas or oil fired	All capacity	80%
FUE - fuel utilization efficiency			

Table 5-20 Minimum Efficiency Requirements for Oil and Gas Fired Boilers for ECBC+ and SuperECBC building

Equipment Type	Sub Category	Size Category	Minimum FUE
Boilers, Hot Water	Gas or oil fired	All capacity	85%
FUE - fuel utilization efficiency			

5.3.6 Energy Recovery

All Hospitality and Healthcare, with systems of capacity greater than 2,100 liters per second and minimum outdoor air supply of 70% shall have air-to-air heat recovery equipment with minimum 50% recovery effectiveness

At least 50% of heat shall be recovered from diesel and gas fired generator sets installed in Hospitality, Healthcare, and Business buildings with built up area greater than 20,000 m².

5.4 Total System Efficiency – Alternate Compliance Approach

Buildings may show compliance by optimizing the total system efficiency for the plant side comfort system instead of the individual equipment mentioned under the prescriptive requirement. This alternate compliance approach is applicable for central chilled water plant side system in all building types. The total installed capacity per kilo-watt refrigeration load shall be less than or equal to maximum threshold requirements as specified in Table 5-21. Equipment that can be included in central chilled water plant side system for this alternate approach are chillers, chilled water pumps, condenser water pumps, and cooling tower fan. Compliance check will be based on annual hourly simulation.

Table 5-21 Minimum System Efficiency* Requirement for ECBC, ECBC+, and SuperECBC Buildings

<i>Water Cooled Chilled Water Plant</i>	<i>Maximum Threshold (kW/kWr)</i>
ECBC	0.26
ECBC+	0.23
SuperECBC	0.20

5.5 Low-energy Comfort Systems

Alternative HVAC systems which have low energy use may be installed in place of (or in conjunction with) refrigerant-based cooling systems. Such systems shall be deemed to meet the minimum space conditioning equipment efficiency levels of §5.2.2, but shall comply with all other applicable mandatory provisions of §5.2 as applicable. The approved list of low energy comfort systems¹ is given below:

- (a) Evaporative cooling
- (b) Desiccant cooling system
- (c) Solar air conditioning
- (d) Tri-generation (waste-to-heat)
- (e) Radiant cooling system
- (f) Ground source heat pump
- (g) Adiabatic cooling system

Buildings with an approved low-energy comfort system installed for more than 50% of the cooling and heating requirement of the building shall be deemed equivalent to the ECBC+ building standard prescribed in § 5.2.2.

Buildings having an approved low energy comfort system installed for more than 90% of the cooling and heating requirement of the building shall be deemed equivalent to the SuperECBC building standard prescribed in §5.2.2.

¹ This is not an all-inclusive list. The updated list of low energy comfort systems is available at BEE website (<https://www.beeindia.gov.in/>).



Thermal Energy Storage

Thermal storage may be used for limiting maximum demand, by controlling peak electricity load through reduction of chiller capacity, and by taking advantage of high system efficiency during low ambient conditions. Thermal storage would also help in reducing operating cost by using differential time-of-the day power tariff, where

applicable.

The storage media can be ice or water. Water need stratified storage tanks and is mostly viable with large storage capacity and has an advantage of plant operation at higher efficiencies but requires larger storage volumes. In case of central plant, designed with thermal energy storage, its location shall be decided in consultation with the air conditioning engineer. For roof top installations, structural provision shall take into account load coming on the building/structure due to the same. For open area surface installation, horizontal or vertical system options shall be considered and approach ladders for manholes provided. Buried installation shall take into account loads due to movement of vehicles above the area.

6 Lighting & Controls



6. Lighting and Controls

6.1 General

Lighting systems and equipment shall comply with the mandatory provisions of § 6.2 and the prescriptive criteria of § 6.3. The lighting requirements in this section shall apply to:

- (a) Interior spaces of buildings,
- (b) Exterior building features, including facades, illuminated roofs, architectural features, entrances, exits, loading docks, and illuminated canopies, and,
- (c) Exterior building grounds lighting that is provided through the building's electrical service.

Exceptions to §6.1:

- (a) Emergency or security lighting that is automatically off during normal building operations.

6.2 Mandatory Requirements

6.2.1 Lighting Control

6.2.1.1 Automatic Lighting Shutoff

- (a) 90% of interior lighting fittings in building or space of building larger than 300 m² shall be equipped with automatic control device.
- (b) Additionally, occupancy sensors shall be provided in
 - i. All building types greater than 20,000 m² BUA, in
 - a. All habitable spaces less than 30 m², enclosed by walls or ceiling height partitions.
 - b. All storage or utility spaces more than 15 m² in all building types with BUA greater than 20,000 m².
 - c. Public toilets more than 25 m², controlling at least 80 % of lighting fitted in the toilet. The lighting fixtures, not controlled by automatic lighting shutoff, shall be uniformly spread in the area.
 - ii. In corridors of all Hospitality greater than 20,000 m² BUA, controlling minimum 70% and maximum 80% of lighting fitted in the public corridor. The lighting fixtures, not controlled by automatic lighting shut off, shall be uniformly spread in the area.
 - iii. In all Business and all conference or meeting rooms.
- (c) Automatic control device shall function on either:

- i. A scheduled basis at specific programmed times. An independent program schedule shall be provided for areas of no more than 2,500 m² and not more than one floor, or,
- ii. Occupancy sensors that shall turn off the lighting fixtures within 15 minutes of an occupant leaving the space. Light fixtures controlled by occupancy sensors shall have a wall-mounted, manual switch capable of turning off lights when the space is occupied.

Exception to § 6.2.1.1: Lighting systems designed for emergency and firefighting purposes.

6.2.1.2 Space Control

Each space enclosed by ceiling-height partitions shall have at least one control device to independently control the general lighting within the space. Each control device shall be activated either manually by an occupant or automatically by sensing an occupant. Each control device shall

- (a) control a maximum of 250 m² for a space less than or equal to 1,000 m², and a maximum of 1,000 m² for a space greater than 1,000 m².
- (b) have the capability to override the shutoff control required in § 6.2.1.1 for no more than 2 hours, and
- (c) be readily accessible and located so the occupants can see the control.

Exception to § 6.2.1.2 (c): The required control device may be remotely installed if required for reasons of safety or security. A remotely located device shall have a pilot light indicator as part of or next to the control device and shall be clearly labeled to identify the controlled lighting.

6.2.1.3 Control in Daylight Areas

- (a) Luminaires, installed within day lighting extent from the window as calculated in § 4.2.3, shall be equipped with either a manual control device to shut off luminaires, installed within day lit area, during potential daylit time of a day or automatic control device that:
 - i. Has a delay of minimum 5 minutes, or,
 - ii. Can dim or step down to 50% of total power.
- (b) Overrides to the daylight controls shall not be allowed.
- (c) For SuperECBC Buildings, Lighting Power Density adjustment factor of 20% shall be allowed to all spaces with more than 70% of their area under daylight controls.

6.2.1.4 Centralized Controls for ECBC+ and SuperECBC Buildings

ECBC+ and SuperECBC building shall have centralized control system for schedule based automatic lighting shutoff switches.

6.2.1.5 Exterior Lighting Control

- (a) Lighting for all exterior applications not exempted in §6.3.5 shall be controlled by a photo sensor or astronomical time switch that is capable of automatically turning off the exterior lighting when daylight is available or the lighting is not required.
- (b) Lighting for all exterior applications, of Schools and Business with built up area greater than 20,000 m², shall have lamp efficacy not less than 80 lumens per watt, 90 lumens per watt, and 100 lumens per watt, for ECBC, ECBC+, and SuperECBC Buildings respectively, unless the luminaire is controlled by a motion sensor or exempt under §6.1.
- (c) Façade lighting and façade non-emergency signage of Shopping Complexes shall have separate time switches.

Exemption to §6.2.1.5: Exterior emergency lighting.

6.2.1.6 Additional Control

The following lighting applications shall be equipped with a control device to control such lighting independently of general lighting:

- (a) Display/ Accent Lighting. Display or accent lighting greater than 300 m² area shall have a separate control device.
- (b) Hotel Guest Room Lighting. Guest rooms and guest suites in a hotel shall have a master control device at the main room entry that controls all permanently installed luminaires and switched receptacles.
- (c) Task Lighting. Supplemental task lighting including permanently installed under shelf or under cabinet lighting shall have a control device integral to the luminaires or be controlled by a wall-mounted control device provided the control device complies with §6.2.1.2.
- (d) Nonvisual Lighting. Lighting for nonvisual applications, such as plant growth and food-warming, shall be equipped with a separate control device.
- (e) Demonstration Lighting. Lighting equipment that is for sale or for demonstrations in lighting education shall be equipped with a separate control device accessible only to authorized personnel.

6.2.2 Exit Signs

Internally-illuminated exit signs shall not exceed 5 Watts per face.

6.3 Prescriptive Requirements

6.3.1 Interior Lighting Power

The installed interior lighting power for a building or a separately metered or permitted portion of a building shall be calculated in accordance with §6.3.4 and shall not exceed the interior lighting power allowance determined in accordance with either §6.3.2 or §6.3.3. Tradeoffs of interior lighting power allowance among portions of the building for which a different method of calculation has been used are not permitted.

Exception to §6.3: The following lighting equipment and applications shall not be considered when determining the interior lighting power allowance, nor shall the wattage for such lighting be included in the installed interior lighting power. However, any such lighting shall not be exempt unless it is an addition to general lighting and is controlled by an independent control device.

- (a) Display or accent lighting that is an essential element for the function performed in galleries, museums, and monuments,
- (b) Lighting that is integral to equipment or instrumentation and is installed by its manufacturer,
- (c) Lighting specifically designed for medical or dental procedures and lighting integral to medical equipment,
- (d) Lighting integral to food warming and food preparation equipment,
- (e) Lighting for plant growth or maintenance,
- (f) Lighting in spaces specifically designed for use by the visually impaired,
- (g) Lighting in retail display windows, provided the display area is enclosed by ceiling-height partitions,
- (h) Lighting in interior spaces that have been specifically designated as a registered interior historic landmark,
- (i) Lighting that is an integral part of advertising or directional signage,
- (j) Exit signs,
- (k) Lighting that is for sale or lighting educational demonstration systems,
- (l) Lighting for theatrical purposes, including performance, stage, and film or video production, and
- (m) Athletic playing areas with permanent facilities for television broadcasting.

6.3.2 Building Area Method

Determination of interior lighting power allowance (watts) by the building area method shall be in accordance with the following:

Determine the allowed lighting power density for each appropriate building area type from Table 6-1 for ECBC Buildings, from Table 6-2 for ECBC+ Buildings and from Table 6-3 for SuperECBC Buildings.

- (a) Calculate the gross lighted carpet area for each building area type.
- (b) The interior lighting power allowance is the sum of the products of the gross lighted floor area of each building area times the allowed lighting power density for that building area type.

Table 6-1 Interior Lighting Power for ECBC Buildings – Building Area Method

<i>Building Type</i>	<i>LPD (W/m²)</i>	<i>Building Area Type</i>	<i>LPD (W/m²)</i>
Office Building	9.50	Motion picture theater	9.43
Hospitals	9.70	Museum	10.2
Hotels	9.50	Post office	10.5
Shopping Mall	14.1	Religious building	12.0
University and Schools	11.2	Sports arena	9.70
Library	12.2	Transportation	9.20
Dining: bar lounge/leisure	12.2	Warehouse	7.08
Dining: cafeteria/fast food	11.5	Performing arts theater	16.3
Dining: family	10.9	Police station	9.90
Dormitory	9.10	Workshop	14.1
Fire station	9.70	Automotive facility	9.00
Gymnasium	10.0	Convention center	12.5
Manufacturing facility	12.0	Parking garage	3.00

In cases where both a general building area type and a specific building area type are listed, the specific building area type shall apply.

Table 6-2 Interior Lighting Power for ECBC+ Buildings – Building Area Method

<i>Building Area Type</i>	<i>LPD (W/m²)</i>	<i>Building Area Type</i>	<i>LPD (W/m²)</i>
Office Building	7.60	Motion picture theater	7.50
Hospitals	7.80	Museum	8.20
Hotels	7.60	Post office	8.40
Shopping Mall	11.3	Religious building	9.60
University and Schools	9.00	Sports arena	7.80
Library	9.80	Transportation	7.40
Dining: bar lounge/leisure	9.80	Warehouse	5.70
Dining: cafeteria/fast food	9.20	Performing arts theater	13.0
Dining: family	8.70	Police station	7.90
Dormitory	7.30	Workshop	11.3
Fire station	7.80	Automotive facility	7.20
Gymnasium	8.00	Convention center	10.0
Manufacturing facility	9.60	Parking garage	2.40
In cases where both a general building area type and a specific building area type are listed, the specific building area type shall apply.			

Table 6-3 Interior Lighting Power for SuperECBC Buildings – Building Area Method

<i>Building Area Type</i>	<i>LPD (W/m²)</i>	<i>Building Area Type</i>	<i>LPD (W/m²)</i>
Office Building	5.0	Motion picture theater	4.7
Hospitals	4.9	Museum	5.1
Hotels	4.8	Post office	5.3
Shopping Mall	7.0	Religious building	6.0
University and Schools	6.0	Sports arena	4.9
Library	6.1	Transportation	4.6
Dining: bar lounge/leisure	6.1	Warehouse	3.5
Dining: cafeteria/fast food	5.8	Performing arts theater	8.2
Dining: family	5.5	Police station	5.0
Dormitory	4.6	Workshop	7.1
Fire station	4.9	Automotive facility	4.5
Gymnasium	5.0	Convention center	6.3
Manufacturing facility	6.0	Parking garage	1.5
In cases where both a general building area type and a specific building area type are listed, the specific building area type shall apply.			

6.3.3 Space Function Method

Determination of interior lighting power allowance (watts) by the space function method shall be in accordance with the following:

- (a) Determine the appropriate building type and the allowed lighting power density from Table 6-4 for ECBC Buildings, Table 6-5 for ECBC+ Buildings and, Table 6-6 for SuperECBC Buildings. In cases where both a common space type and building specific space type are listed, building specific space type LPD shall apply.
- (b) For each space, enclosed by partitions 80% or greater than ceiling height, determine the gross carpet area by measuring to the face of the partition wall. Include the area of balconies or other projections. Retail spaces do not have to comply with the 80% partition height requirements.
- (c) The interior lighting power allowance is the sum of the lighting power allowances for all spaces. The lighting power allowance for a space is the product of the gross lighted carpet area of the space times the allowed lighting power density for that space.

Table 6-4 Interior Lighting Power for ECBC Buildings – Space Function Method

Category	LPD (W/m ²)	Lamp category	LPD (W/m ²)
Common Space Types			
Restroom	7.70	Stairway	5.50
Storage	6.80	Corridor/Transition	7.10
Conference/ Meeting	11.5	Lobby	9.10
Parking Bays (covered/ basement)	2.20	Parking Driveways (covered/ basement)	3.00
Electrical/Mechanical	7.10	Workshop	17.1
Business			
Enclosed	10.0	Open Plan	10.0
Banking Activity Area	12.6	Service/Repair	6.80
Healthcare			
Emergency	22.8	Recovery	8.60
Exam/Treatment	13.7	Storage	5.50
Nurses' Station	9.40	Laundry/Washing	7.50
Operating Room	21.8	Lounge/Recreation	8.00
Patient Room	7.70	Medical Supply	13.7
Pharmacy	10.7	Nursery	5.70
Physical Therapy	9.70	Corridor/Transition	9.10
Radiology/Imaging	9.10		

<i>Category</i>	<i>LPD (W/m²)</i>	<i>Lamp category</i>	<i>LPD (W/m²)</i>
Hospitality			
Hotel Dining	9.10	Hotel Lobby	10.9
For Bar Lounge/ Dining	14.1	Motel Dining	9.10
For food preparation	12.1	Motel Guest Rooms	7.70
Hotel Guest Rooms	9.10		
Shopping Complex			
Mall Concourse	12.8	For Family Dining	10.9
Sales Area	18.3	For food preparation	12.1
Motion Picture Theatre	9.60	Bar Lounge/ Dining	14.1
Educational			
Classroom/Lecture	13.7	Card File and Cataloguing	9.10
For Classrooms	13.8	Stacks (Lib)	18.3
Laboratory	15.1	Reading Area (Library)	10.0
Assembly			
Dressing Room	9.10	Seating Area - Performing Arts Theatre	22.6
Exhibit Space - Convention Centre	14.0	Lobby - Performing Arts Theatre	21.5
Seating Area - Gymnasium	4.60	Seating Area - Convention Centre	6.40
Fitness Area - Gymnasium	13.70	Seating Religious Building	16.4
Museum - General Exhibition	16.40	Playing Area - Gymnasium	18.8
Museum - Restoration	18.3		

Table 6-5 Interior Lighting Power for ECBC+ Buildings – Space Function Method

Category	LPD (W/m ²)	Lamp category	LPD (W/m ²)
Common Space Types			
Restroom	6.10	Stairway	4.40
Storage	5.40	Corridor/Transition	3.60
Conference/ Meeting	9.20	Lobby	7.30
Parking Bay (covered/ basement)	1.75	Parking Driveways (covered/ basement)	2.50
Electrical/Mechanical	5.70	Workshop	13.7
Business			
Enclosed	8.60	Open Plan	8.60
Banking Activity Area	9.30	Service/Repair	5.50
Healthcare			
Emergency	18.2	Recovery	7.00
Exam/Treatment	10.9	Storage	4.40
Nurses' Station	7.50	Laundry/Washing	6.00
Operating Room	17.5	Lounge/Recreation	6.40
Patient Room	6.10	Medical Supply	10.9
Pharmacy	8.50	Nursery	4.60
Physical Therapy	7.80	Corridor/Transition	7.30
Radiology/Imaging	7.30		
Hospitality			
Hotel Dining	7.30	Hotel Lobby	8.80
For Bar Lounge/ Dining	11.3	Motel Dining	7.30
For food preparation	12.1	Motel Guest Rooms	6.10
Hotel Guest Rooms	7.30		
Shopping Complex			
Mall Concourse	10.2	For Family Dining	8.80
Sales Area	14.6	For food preparation	12.1
Motion Picture Theatre	10.3	Bar Lounge/ Dining	11.3
Educational			
Classroom/Lecture	10.9	Card File and Cataloguing	7.30
For Classrooms	11.0	Stacks (Library)	14.6
Laboratory	12.1	Reading Area (Library)	9.20
Assembly			
Dressing Room	7.30	Seating Area - Performing Arts Theatre	18.1

<i>Category</i>	<i>LPD (W/m²)</i>	<i>Lamp category</i>	<i>LPD (W/m²)</i>
Exhibit Space - Convention Centre	11.2	Lobby - Performing Arts Theatre	17.2
Seating Area - Gymnasium	3.60	Seating Area – Convention Centre	5.10
Fitness Area - Gymnasium	7.85	Seating Religious Building	13.1
Museum - General Exhibition	11.3	Playing Area - Gymnasium	12.9
Museum - Restoration	11.0		

Table 6-6 Interior Lighting Power for SuperECBC Buildings – Space Function Method

<i>Category</i>	<i>LPD (W/m²)</i>	<i>Lamp category</i>	<i>LPD (W/m²)</i>
Common Space Types			
Restrooms	3.80	Stairway	2.70
Storage	3.40	Corridor/Transition	2.30
Conference/ Meeting	5.70	Lobby	4.60
Parking Bays (covered/ basement)	1.10	Driveways (covered/ basement)	1.50
Electrical/Mechanical	3.50	Workshop	8.60
Business			
Enclosed	5.40	Open Plan	5.40
Banking Activity Area	5.80	Service/Repair	3.40
Healthcare			
Emergency	11.4	Recovery	4.40
Exam/Treatment	6.80	Storage	2.70
Nurses' Station	5.00	Laundry/Washing	3.80
Operating Room	10.9	Lounge/Recreation	4.60
Patient Room	3.80	Medical Supply	6.80
Pharmacy	5.30	Nursery	2.90
Physical Therapy	4.90	Corridor/Transition	4.60
Radiology/Imaging	4.60		
Hospitality			
Hotel Dining	4.60	Hotel Lobby	5.50
For Bar Lounge/ Dining	7.00	Motel Dining	4.60
For food preparation	7.50	Motel Guest Rooms	3.80
Hotel Guest Rooms	4.60		
Shopping Complex			
Mall Concourse	6.40	For Family Dining	5.50

<i>Category</i>	<i>LPD (W/m²)</i>	<i>Lamp category</i>	<i>LPD (W/m²)</i>
Sales Area	9.20	For food preparation	7.50
Motion Picture Theatre	6.50	Bar Lounge/ Dining	7.00
Educational			
Classroom/Lecture	6.80	Card File and Cataloguing	4.60
For Classrooms	6.90	Stacks (Library)	9.20
Laboratory	7.50	Reading Area (Library)	5.70
Assembly			
Dressing Room	4.60	Seating Area - Performing Arts Theatre	11.3
Exhibit Space – Convention Centre	7.00	Lobby - Performing Arts Theatre	10.8
Seating Area - Gymnasium	3.40	Seating Area – Convention Centre	3.20
Fitness Area - Gymnasium	3.92	Seating Religious Building	8.20
Museum – General Exhibition	5.65	Playing Area - Gymnasium	6.50
Museum – Restoration	5.50		

Note 6-1 Calculating Interior Lighting Power – Space Function Method



A four-story building has retail on the ground floor and offices on the top three floors. Area is 3,600 m². Space types and their respective areas are mentioned below. Steps for calculating interior lighting power allowance using the space function method for a ECBC building is described below.

For each of the space type, corresponding Lighting Power Density (LPD) values for Business and Shopping complex building type from Table 6-4 are used. Area is multiplied with the LPD values to estimate the lighting power allowance for the whole building. It is 40,055.5 W.

Table 6-1-1 Space Types, Areas and Corresponding LPDs

Space Function	LPD (W/m ²)	Area (m ²)	Lighting Power Allowance (W)
<i>Office</i>			
Office - enclosed	10.0	720	7,200
Office – open plan	10.0	1,485	14,850
Meeting Rooms	11.5	120	1,380
Lobbies	7.1	93	660
Restrooms	7.7	51	393
Corridors	7.1	125	887.5
Electrical/ Mechanical	7.1	14	99
Staircase	5.5	84	462
<i>Total</i>			25,931.5
<i>Retail</i>			
General sales area	18.3	669	12,243
Offices - enclosed	10.0	28	280
Restrooms	7.7	9	69
Corridors	7.1	79	561
Active Storage	6.8	93	632
Food preparation	12.1	28	339
<i>Total</i>			14,124
<i>Building Total</i>			40,055.5 W

6.3.4 Installed Interior Lighting Power

The installed interior lighting power calculated for compliance with §6.3 shall include all power used by the luminaires, including lamps, ballasts, current regulators, and control devices except as specifically exempted in §6.1.

Exception to §6.3.4: If two or more independently operating lighting systems in a space are controlled to prevent simultaneous user operation, the installed interior lighting power shall be based solely on the lighting system with the highest power.

6.3.4.1 Luminaire Wattage

Luminaire efficacy shall be 0.7 or above. Luminaire wattage incorporated into the installed interior lighting power shall be determined in accordance with the following:

- (a) The wattage of incandescent luminaires with medium base sockets and not containing permanently installed ballasts shall be the maximum labeled wattage of the luminaires.
- (b) The wattage of luminaires containing permanently installed ballasts shall be the operating input wattage of the specified lamp/ballast combination. Operating input wattage can be either values from manufacturers' catalogs or values from independent testing laboratory reports.
- (c) The wattage of all other miscellaneous luminaire types not described in (a) or (b) shall be the specified wattage of the luminaires.
- (d) The wattage of lighting track, plug-in busway, and flexible-lighting systems that allow the addition and/or relocation of luminaires without altering the wiring of the system shall be the larger of the specified wattage of the luminaires included in the system or 135 Watt per meter (45 W/ft.). Systems with integral overload protection, such as fuses or circuit breakers, shall be rated at 100% of the maximum rated load of the limiting device.

6.3.5 Exterior Lighting Power

Connected lighting power of exterior lighting applications shall not exceed the lighting power limits specified in Table 6-7 for ECBC Buildings, Table 6-8 for ECBC+ Buildings and Table 6-9 for SuperECBC Buildings. Trade-offs between applications are not permitted.

Table 6-7 Exterior Building Lighting Power for ECBC Buildings

<i>Exterior lighting application</i>	<i>Power limits</i>
Building entrance (with canopy)	10 W/m ² of canopied area
Building entrance (w/o canopy)	90 W/ linear m of door width
Building exit	60 W/lin m of door width
Building façade	5.0 W/m ² of vertical façade area
Emergency signs, ATM kiosks, Security areas façade	1.0 W/m ²
Driveways and parking (open/ external)	1.6 W/m ²
Pedestrian walkways	2.0 W/m ²
Stairways	10.0 W/m ²
Landscaping	0.5 W/m ²
Outdoor sales area	9.0 W/m ²

Table 6-8 Exterior Building Lighting Power for ECBC+ Buildings

<i>Exterior lighting application</i>	<i>Power limits</i>
Building entrance (with canopy)	8.0 W/m ² of canopied area
Building entrance (w/o canopy)	72 W/ linear m of door width
Building exit	48 W/lin m of door width
Building façade	4.0 W/m ² of vertical façade area
Emergency signs, ATM kiosks, Security areas façade	0.8 W/m ²
Driveways and parking (open/ external)	1.3 W/m ²
Pedestrian walkways	1.6 W/m ²
Stairways	8.0 W/m ²
Landscaping	0.4 W/m ²
Outdoor sales area	7.2 W/m ²

Table 6-9 Exterior Building Lighting Power for SuperECBC Buildings

<i>Exterior lighting application</i>	<i>Power limits</i>
Building entrance (with canopy)	5.0 W/m ² of canopied area
Building entrance (w/o canopy)	45 W/ linear m of door width
Building exit	30 W/lin m of door width
Building façade	2.5 W/m ² of vertical façade area
Emergency signs, ATM kiosks, Security areas façade	0.5 W/m ²
Driveways and parking (open/ external)	0.8 W/m ²
Pedestrian walkways	1.0 W/m ²
Stairways	5.0 W/m ²
Landscaping	0.25 W/m ²
Outdoor sales area	4.5 W/m ²

7 Electrical & Renewable Energy Systems

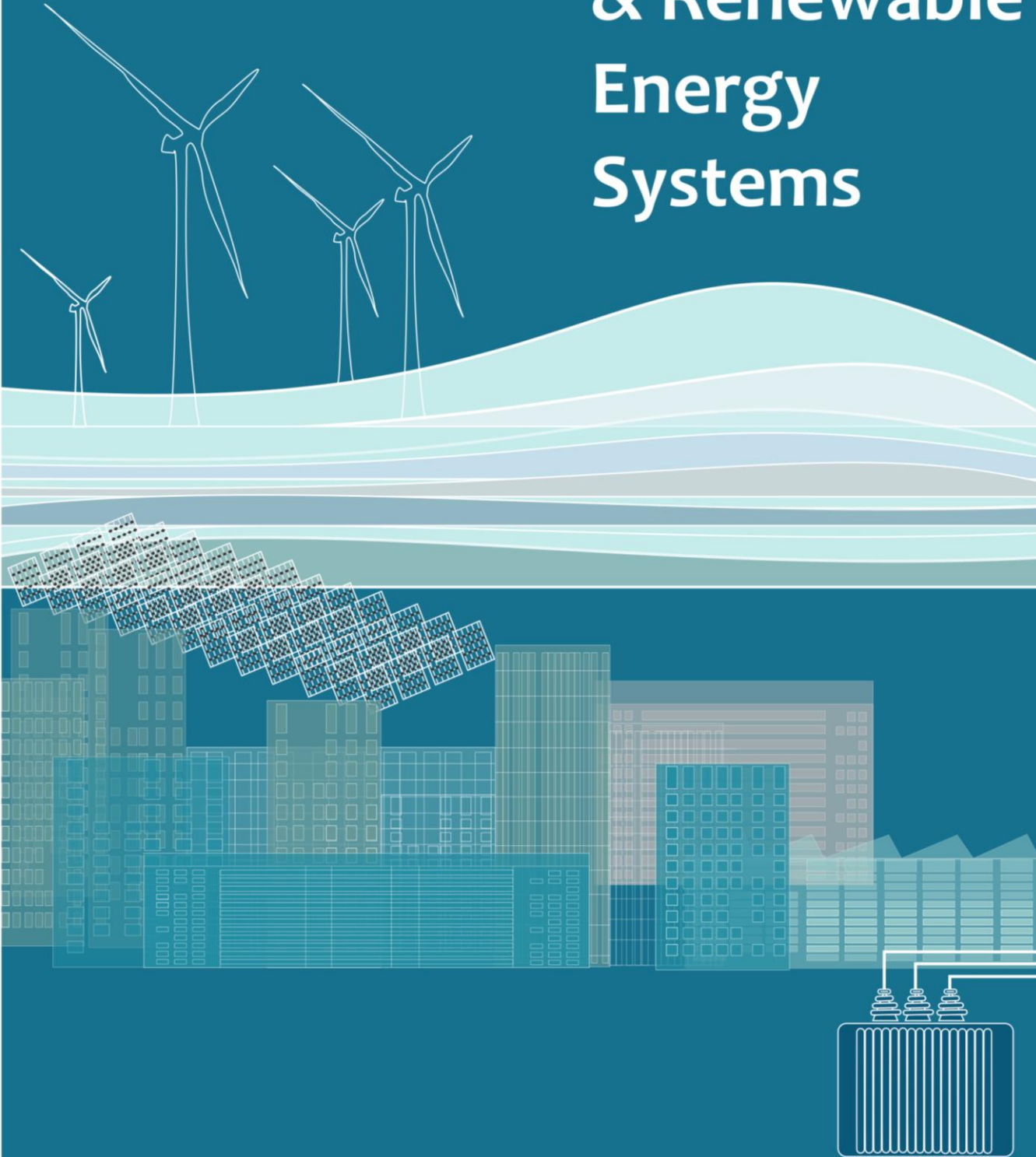

7. Electrical and Renewable Energy Systems

7.1 General

All electric and renewable energy equipment and systems shall comply with the mandatory requirements of §7.2.

7.2 Mandatory Requirements

7.2.1 Transformers

7.2.1.1 Maximum Allowable Power Transformer Losses

Power transformers of the proper ratings and design must be selected to satisfy the minimum acceptable efficiency at 50% and full load rating.

Permissible total loss values shall not exceed

- (a) 5% of the maximum total loss values mentioned in IS 1180 for oil type transformers in voltage class above 11 kV but not more than 22 kV
- (b) 7.5% of the maximum total loss values mentioned in above IS 1180 for oil type transformers in voltage class above 22 kV and up to and including 33 kV
- (c) values listed in Table 7.1 for dry type transformers

Table 7-1 Dry Type Transformers

Rating (kVA)	Impedance (%)	Max. Total Loss (W)					
		ECBC Building		ECBC+ Building		SuperECBC Building	
		50 % Load	100% Load	50 % Load	100% Load	50 % Load	100% Load
16	4.5	150	480	135	440	120	400
25	4.5	210	695	190	635	175	595
63	4.5	380	1,250	340	1,140	300	1,050
100	4.5	520	1,800	475	1,650	435	1,500
160	4.5	770	2,200	670	1,950	570	1,700
200	4.5	890	2,700	780	2,300	670	2,100
250	4.5	1,050	3,150	980	2,930	920	2,700
315	4.5	1,100	3,275	1,025	3,100	955	2,750
400	4.5	1,300	3,875	1,225	3,450	1,150	3,330
500	4.5	1,600	4,750	1,510	4,300	1,430	4,100
630	4.5	2,000	5,855	1,860	5,300	1,745	4,850
1000	5	3,000	9,000	2,790	7,700	2,620	7,000
1250	5	3,600	1,0750	3,300	9,200	3,220	8,400
1600	6.25	4,500	13,500	4,200	11,800	3,970	11,300
2000	6.25	5,400	17,000	5,050	15,000	4,790	14,100
2500	6.25	6,500	20,000	6,150	18,500	5,900	17,500

Total loss values given in above table are applicable for thermal classes E, B and F and have component of load loss at reference temperature according to Clause 17 of IS. An increase of 7% on total for thermal class H is allowed.

Table 7-2 Permissible Losses for Oil Type Transformers. Total losses for oil type transformers shall conform with Indian Standard IS 1180.

Rating (kVA)	Impedance (%)	Max. Total Loss (W)					
		ECBC Building		ECBC+ Building		SuperECBC Building	
		50 % Load	100% Load	50 % Load	100% Load	50 % Load	100% Load
16	4.5	150	480	135	440	120	400
25	4.5	210	695	190	635	175	595
63	4.5	380	1250	340	1140	300	1050
100	4.5	520	1800	475	1650	435	1500
160	4.5	770	2200	670	1950	570	1700
200	4.5	890	2700	780	2300	670	2100
250	4.5	1050	3150	980	2930	920	2700
315	4.5	1100	3275	1025	3100	955	2750
400	4.5	1300	3875	1225	3450	1150	3330
500	4.5	1600	4750	1510	4300	1430	4100
630	4.5	2000	5855	1860	5300	1745	4850
1000	5	3000	9000	2790	7700	2620	7000
1250	5	3600	10750	3300	9200	3220	8400
1600	6.25	4500	13500	4200	11800	3970	11300
2000	6.25	5400	17000	5050	15000	4790	14100
2500	6.25	6500	20000	6150	18500	5900	17500

Total loss values given in above table are applicable for thermal classes E, B and F and have component of load loss at reference temperature according to Clause 17 of IS 1180 i.e., average winding temperature rise as given in Column 2 of Table 8.2 plus 300C. An increase of 7% on total for thermal class H is allowed.

7.2.1.2 Measurement and Reporting of Transformer Losses

All measurement of losses shall be carried out by using calibrated digital meters of class 0.5 or better accuracy and certified by the manufacturer. All transformers of capacity of 500 kVA and above would be equipped with additional metering class current transformers (CTs) and potential transformers (PTs) additional to requirements of Utilities so that periodic loss monitoring study may be carried out.

7.2.1.3 Voltage Drop

Voltage drop for feeders shall not exceed 2% at design load. Voltage drop for branch circuit shall not exceed 3% at design load.

7.2.2 Energy Efficient Motors

Motors shall comply with the following:

- (a) Three phase induction motors shall conform to Indian Standard (IS) 12615 and shall fulfil the following efficiency requirements:
 - i. ECBC Buildings shall have motors of IE 2 (high efficiency) class or a higher class
 - ii. ECBC+ Buildings shall have IE 3 (premium efficiency) class motors or higher class
 - iii. SuperECBC Buildings shall have IE 4 (super premium efficiency) class motors
- (b) All permanently wired polyphase motors of 0.375 kW or more serving the building and expected to operate more than 1,500 hours per year and all permanently wired polyphase motors of 50kW or more serving the building and expected to operate more than 500 hour per year, shall have a minimum acceptable nominal full load motor efficiency not less than levels specified in the latest version of IS 12615.
- (c) Motors of horsepower differing from those listed in the table shall have efficiency greater than that of the next listed kW motor.
- (d) Motor horsepower ratings shall not exceed 20% of the calculated maximum load being served.
- (e) Motor nameplates shall list the nominal full-load motor efficiencies and the full-load power factor.
- (f) Motor users should insist on proper rewinding practices for any rewind motors. If the proper rewinding practices cannot be assured, the damaged motor should be replaced with a new, efficient one rather than suffer the significant efficiency penalty associated with typical rewind practices. Rewinding practices from BEE guideline for energy efficient motors shall be followed.
- (g) Certificates shall be obtained and kept on record indicating the motor efficiency. Whenever a motor is rewound, appropriate measures shall be taken so that the core characteristics of the motor is not lost due to thermal and mechanical stress during removal of damaged parts. After rewinding, a new efficiency test shall be performed and a similar record shall be maintained.

7.2.3 Diesel Generator (DG) Sets

BEE star rated DG sets shall be used in all compliant buildings. DG sets in buildings greater than 20,000 m² BUA shall have:

- (a) minimum 3 stars rating in ECBC Buildings
- (b) minimum 4 stars rating in ECBC+ Buildings
- (c) minimum 5 stars rating in SuperECBC Buildings

7.2.4 Check-Metering and Monitoring

- Services exceeding 1000 kVA shall have permanently installed electrical metering to record demand (kVA), energy (kWh), and total power factor. The metering shall also display current (in each phase and the neutral), voltage (between phases and between each phase and neutral), and total harmonic distortion (THD) as a percentage of total current.
- Services not exceeding 1000 kVA but over 65 kVA shall have permanently installed electric metering to record demand (kW), energy (kWh), and total power factor (or kVARh).
- Services not exceeding 65 kVA shall have permanently installed electrical metering to record energy (kWh).
- In case of tenant based building, metering should be provided at a location from where each tenant could attach the services.

Table 7-3 Sub Metering Requirements

	120 kVA to 250 kVA	Greater than 250 kVA
Minimum requirement for metering of electrical load		
Energy kWh	Required	Required
Demand kVA	Required	Required
Total power factor	Required	Required
Minimum requirement for separation of electrical load		
HVAC system and components	Required	Required
Interior and Exterior Lighting *	Not required	Required
Domestic hot water	Not required	Required
Plug loads	Not required	Required
Renewable power source	Required	Required
Mandatory requirement for building type over the requirement stated above		
Shopping Complex	Façade lighting	Elevator, escalators, moving walks
Business	Data centers	
Hospitality	Commercial kitchens	
* Hotel guestrooms and hospital in patient areas are exempted from the lighting sub-metering requirements.		

7.2.5 Power Factor Correction

All 3 phase shall maintain their power factor at the point of connection as follows:

- (a) 0.97 for ECBC Building
- (b) 0.98 for ECBC+ building
- (c) 0.99 for SuperECBC building

7.2.6 Power Distribution Systems

The power cabling shall be sized so that the distribution losses do not exceed

- (a) 3% of the total power usage in ECBC Buildings
- (b) 2% of the total power usage in ECBC+ Buildings
- (c) 1% of total power usage in SuperECBC Buildings

Record of design calculation for the losses shall be maintained. Load calculation shall be calculated up to the panel level.

7.2.7 Uninterruptible Power Supply (UPS)

In all buildings, UPS shall meet or exceed the energy efficiency requirements listed in Table 7-4. Any Standards and Labeling program by BEE shall take precedence over requirements listed in this section.

Table 7-4 Energy Efficiency Requirements for UPS for ECBC, ECBC+, SuperECBC building

<i>UPS Size</i>	<i>Energy Efficiency Requirements at 100% Load</i>
kVA < 20	90.2%
20 ≤ kVA ≤ 100	91.9%
kVA > 100	93.8%

7.2.8 Renewable Energy Systems

All buildings shall have provisions for installation of renewable energy systems in the future on rooftops or the site.

7.2.8.1 Renewable Energy Generating Zone (REGZ)

- (a) A dedicated REGZ equivalent to at least 25 % of roof area or area required for generation of energy equivalent to 1% of total peak demand or connected load of the building, whichever is less, shall be provided in all buildings.
- (b) The REGZ shall be free of any obstructions within its boundaries and from shadows cast by objects adjacent to the zone
- (c) ECBC+ and SuperECBC building shall fulfil the additional requirements listed in Table 7-5 and Table 7-6 respectively.

Exception to § 7.2.8.1: Projects with solar hot water and/ or solar power generation systems.

Table 7-5 Minimum Solar Zone Area/Renewable Energy Generating Zone Requirement for ECBC+ Building

<i>Building Type</i>	<i>Minimum Electricity to be Generated in REGZ</i>
All building types except below	Minimum 2% of total electrical load
Star Hotel > 20,000 m ²	Minimum 3% of total electricity load
Resort > 12,500 m ²	
University > 20,000 m ²	
Business >20,000 m ²	

Table 7-6 Minimum Solar Zone Area/Renewable Energy Generating Zone Requirement for SuperECBC Building

<i>Building Type</i>	<i>Minimum Electricity to be Generated in REGZ</i>
All Building types except below	Minimum 4% of total electrical load
Star Hotel > 20,000 m ²	Minimum 6% of total electrical load
Resort > 12,500 m ²	
University > 20,000 m ²	
Business >20,000 m ²	

7.2.8.2 Main Electrical Service Panel

Minimum rating shall be displayed on the main electrical service panel. Space shall be reserved for the installation of a double pole circuit breaker for a future solar electric installation.

7.2.8.3 Demarcation on Documents

The following shall be indicated in design and construction documents:

- (a) Location for inverters and metering equipment,
- (b) Pathway for routing of conduit from the REGZ to the point of interconnection with the electrical service,
- (c) Routing of plumbing from the REGZ to the water-heating system and,
- (d) Structural design loads for roof dead and live load.

8 Definitions, Abbreviations & Acronyms

8. Definitions, Abbreviations, and Acronyms

8.1 General

Certain terms, abbreviations, and acronyms are defined in this section for the purposes of this code. These definitions are applicable to all sections of this code. Terms that are not defined shall have their ordinarily accepted meanings within the context in which they are used.

8.2 Definitions

A

Above grade area (AGA): AGA is the cumulative floor area of all the floor levels of a building that are above the ground level. Ground level shall be as defined in building site plan. A floor level is above grade if one-third of the total external surface area of only the said floor level is above the ground level.

Accredited independent laboratory: testing laboratory not affiliated with producer or consumer of goods or products tested at the laboratory and accredited by national or international organizations for technical competence

Addition: an extension or increase in floor area or height of a building outside of the existing building envelope.

Air conditioning and condensing units serving computer rooms: air conditioning equipment that provides cooling by maintaining space temperature and humidity within a narrow range. Major application is in data centers where dissipating heat generated by equipment takes precedence over comfort cooling for occupants.

Alteration: any change, rearrangement, replacement, or addition to a building or its systems and equipment; any modification in construction or building equipment.

Area weighted average (AWA) method: AWA method is based on the concept of weighted arithmetic mean where instead of each data point contributing equally to the final mean; each data point contributes more “weight” than others based on the size of the area the said data point is applicable to. To calculate the area weighted average mean, a summation of each data point multiplied with its respective area is divided with the total area.

$$AWA = \sum \frac{(\text{Data point } X \text{ area})}{\text{Total area}}$$

Astronomical time switch: an automatic time switch that makes an adjustment for the length of the day as it varies over the year.

Authority having jurisdiction: the agency or agent responsible for enforcing this Standard.

B

Balancing, air system: adjusting airflow rates through air distribution system devices, such as fans and diffusers, by manually adjusting the position of dampers, splitters vanes, extractors, etc., or by using automatic control devices, such as constant air volume or variable air volume boxes.

Balancing, hydronic system: adjusting water flow rates through hydronic distribution system devices, such as pumps and coils, by manually adjusting the position valves, or by using automatic control devices, such as automatic flow control valves.

Ballast: a device used in conjunction with an electric-discharge lamp to cause the lamp to start and operate under proper circuit conditions of voltage, current, waveform, electrode heat, etc.

Standard Design: a computer model of a hypothetical building, based on actual building design, that fulfils all the mandatory requirements and minimally complies with the prescriptive requirements of ECBC.

Boiler: a self-contained low-pressure appliance for supplying steam or hot water

Building or building complex or complex: a structure wholly or partially enclosed within exterior walls, or within exterior and party walls, and a roof, affording shelter to persons, animals, or property. Building complex means a building or group of buildings constructed in a contiguous area for business, commercial, institutional, healthcare, hospitality purposes or assembly buildings under the single ownership of individuals or group of individuals or under the name of a co-operative group society or on lease and sold as shops or office space or space for other commercial purposes, having a connected load of 100 kW or contract demand of 120 kVA and above.

Building, base: includes building structure, building envelope, common areas, circulation areas, parking, basements, services area, plant room and its supporting areas and, open project site area.

Building, core and shell: buildings where the developer or owner will only provide the base building and its services.

Building, existing: a building or portion thereof that was previously occupied or approved for occupancy by the authority having jurisdiction.

Building envelope: the exterior plus the semi-exterior portions of a building. For the purposes of determining building envelope requirements, the classifications are defined as follows:

- (a) **Building envelope, exterior:** the elements of a building that separate conditioned spaces from the exterior
- (b) **Building envelope, semi-exterior:** the elements of a building that separate conditioned space from unconditioned space or that enclose semi-heated spaces through which thermal energy may be transferred to or from the exterior, or to or from unconditioned spaces, or to or from conditioned spaces

Building grounds lighting: lighting provided through a building's electrical service for parking lot, site, roadway, pedestrian pathway, loading dock, and security applications

Building material: any element of the building envelope through which heat flows and that heat is included in the component U-factor calculations other than air films and insulation

Built up area (BUA): sum of the covered areas of all floors of a building, other than the roof, and areas covered by external walls and parapet on these floors.

24-hour Business Building: Business building operated and occupied for more than 12 hours on each weekday. Intensity of occupancy may vary.

C

Cardinal direction: cardinal directions or cardinal points are the four main directional points of a compass: north, south, east, and west which are also known by the first letters: N,S,E, and W.

Carpet area: net area measured between external walls, from the inner faces of walls. Thickness of internal or partition walls is excluded.

Centralized control: single hardware/ software for observing and controlling operations of a group of equipment and devices with similar or different functions

Circuit breaker: a safety device that automatically stops flow of current in electrical circuits. It protects the circuit from current surge.

Class of construction: classification that determines the construction materials for the building envelope, roof, wall, floor, slab-on-grade floor, opaque door, vertical fenestration, skylight

Daylight window: fenestration 2.2 meter above floor level, with an interior light shelf at bottom of this fenestration

Coefficient of Performance (COP) – cooling: the ratio of the rate of heat removal to the rate of energy input, in consistent units, for a complete refrigerating system or some specific portion of that system under designated operating conditions

Coefficient of Performance (COP) – heating: the ratio of the rate of heat delivered to the rate of energy input, in consistent units, for a complete heat pump system, including the compressor and, if applicable, auxiliary heat, under designated operating conditions

Common area: areas within a building that are available for use by all tenants in a building (i.e. lobbies, corridors, restrooms, etc.)

Commercial building: a building or a part of building or building complex which are used or intended to be used for commercial purposes and classified as per the time of the day the building is operational and sub classified, as per the functional requirements of its design, construction, and use as per following details:

- a) Group I – 24 hours building covering Type A Hospitality, Type B Health Care and Type C Assembly and,
- b) Group II – Regular building covering Type D Business, Type E Educational and Type F Shopping Complexes.

Compliance documents: the forms specified in ECBC Rules and Regulations to record and check compliance with these rules. These include but are not limited to EPI Ratio Compliance Report, Building Envelope Compliance Form, Mechanical Systems Compliance Form and Permit Checklist, Lighting System Compliance Form and Permit Checklist and certificates from Certified Energy Auditor for existing or proposed buildings.

Connected load: the sum of the rated wattage of all equipment, appliances and devices to be installed in the building or part of building or building complexes, in terms of kilowatt (kW) that will be allocated to all applicants for electric power consumption in respect of the proposed building or building complexes on their completion.

Contract demand: the maximum demand in kilowatt (kW) or kilo Volt Ampere (kVA) (within a consumer's sanctioned load) agreed to be supplied by the electricity provider or utility in the agreement executed between the user and the utility or electricity provider.

Construction documents: drawings or documents, containing information pertaining to building construction processes and approvals, building materials and equipment specification, architectural details etc. required by the authority having jurisdiction.

Controls or control device: manually operated or automatic device or software to regulate the operation of building equipment

Cool roof: roof with top layer of material that has high solar reflectance and high thermal emittance properties. Cool roof surfaces are characterized by light colors so that heat can be rejected back to the environment.

Cumulative design EPI: energy performance index for a building having two or more different functional uses and calculated based on the area weighted average (AWA) method

D

Daylight area: the daylight illuminated floor area under horizontal fenestration (skylight) or adjacent to vertical fenestration (window), described as follows:

- (a) Horizontal Fenestration: the area under a skylight, monitor, or sawtooth configuration with an effective aperture greater than 0.001 (0.1%). The daylight

area is calculated as the horizontal dimension in each direction equal to the top aperture dimension in that direction plus either the floor-to-ceiling height (H) for skylights, or $1.5H$ for monitors, or H or $2H$ for the sawtooth configuration, or the distance to the nearest 1 meter or higher opaque partition, or one-half the distance to an adjacent skylight or vertical glazing, whichever is least, as shown in the plan and section figures below.

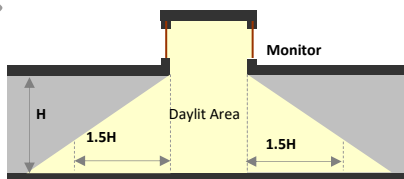
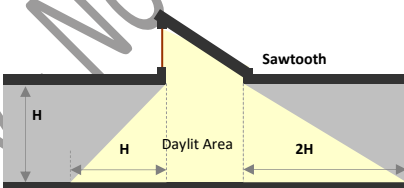
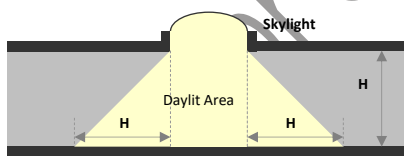
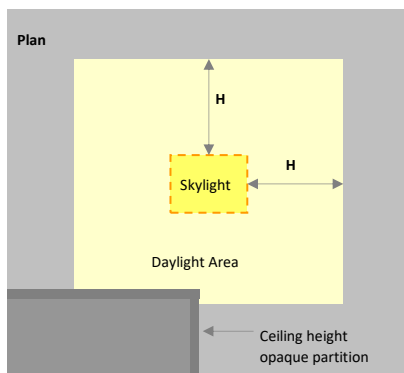

- (b) Vertical Fenestration: the floor area adjacent to side apertures (vertical fenestration in walls) with an effective aperture greater than 0.06 (6%). The daylight area extends into the space perpendicular to the side aperture a distance equal to daylight extension factor (DEF) multiplied by the head height of the side aperture or till higher opaque partition, whichever is less. In the direction parallel to the window, the daylight area extends a horizontal dimension equal to the width of the window plus either 1 meter on each side of the aperture, or the distance to an opaque partition, or one-half the distance to an adjacent skylight or window, whichever is least.

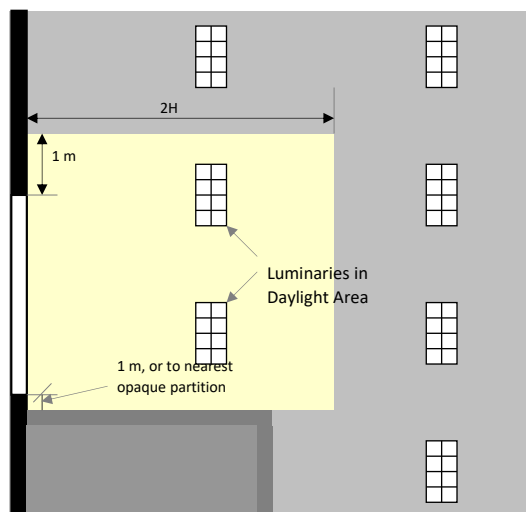

Daylight Extension Factor (DEF): factor to manually calculate the daylight area on floor plates. It is to be multiplied by the head height of windows. It is dependent on orientation and glazing VLT, shading devices adjacent to it and building location.

Daytime Business Building: Business building operated typically only during daytime on weekdays upto 12 hours each day.

Deadband: the range of values within which a sensed variable can vary without initiating a change in the controlled process.

Demand: maximum rate of electricity (kW) consumption recorded for a building or facility during a selected time frame.

Demand control ventilation (DCV): a ventilation system capability that provides automatic reduction of outdoor air intake below design rates when the actual occupancy of spaces served by the system is less than design occupancy

Design capacity: output capacity of a mechanical or electrical system or equipment at design conditions

Design conditions: specified indoor environmental conditions, such as temperature, humidity and light intensity, required to be produced and maintained by a system and under which the system must operate

Distribution system: network or system comprising controlling devices or equipment and distribution channels (cables, coils, ducts, pipes etc.) for delivery of electrical power or, cooled or heated water or air in buildings

Door: all operable opening areas, that are not more than one half glass, in the building envelope, including swinging and roll-up doors, fire doors, and access hatches. For the purposes of determining building envelope requirements, the door types are defined as follows:

- (a) Door, non-swinging: roll-up sliding, and all other doors that are not swinging doors.
- (b) Door, swinging: all operable opaque panels with hinges on one side and opaque revolving doors.

Door area: total area of the door measured using the rough opening and including the door slab and the frame.

E

Economizer, air: a duct and damper arrangement with automatic controls that allow a cooling system to supply outdoor air to reduce or eliminate the need for mechanical cooling during mild or cold weather

Economizer, water: a system by which the supply air of a cooling system is cooled indirectly with water that is itself cooled by heat or mass transfer to the environment without the use of mechanical cooling

ECBC Building: a building that complies with the mandatory requirements of §4 to §7 and also complies either with the prescriptive requirements stated under the ECBC Building categories of §4 to §7, or, with the whole building performance compliance method of §9.

ECBC+ Building: a building that complies with the mandatory requirements of §4 to §7 and also complies either with the prescriptive requirements stated under the ECBC+ Building categories of §4 to §7, or, with the whole building performance compliance method of §9. This is a voluntary level of compliance with ECBC.

Effective aperture: Visible Light Transmittance x window-to-wall Ratio. ($EA = VLT \times WWR$)

Effective aperture, horizontal fenestration: a measure of the amount of daylight that enters a space through horizontal fenestration (skylights). It is the ratio of the skylight area times the visible light transmission divided by the gross roof area above the daylight area. See also daylight area.

Effective aperture, vertical fenestration: a measure of the amount of daylight that enters a space through vertical fenestration. It is the ratio of the daylight window area times its visible light transmission plus half the vision glass area times its visible light transmission and the sum is divided by the gross wall area. Daylight window area is located 2.2 m or more above the floor and vision window area is located above 1 m but below 2.2 m. The window area, for the purposes of determining effective aperture shall not include windows located in light wells when the angle of obstruction (α) of objects obscuring the sky dome is greater than 70° , measured from the horizontal, nor shall it include window area located below a height of 1 m. See also daylight area.

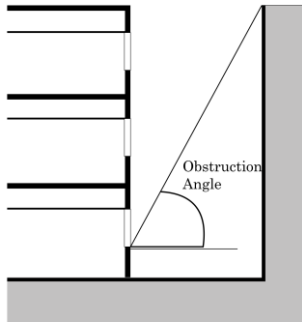

Efficacy: the lumens produced by a lamp plus ballast system divided by the total watts of input power (including the ballast), expressed in lumens per watt

Efficiency: performance at a specified rating condition

Efficiency, thermal: ratio of work output to heat input

Efficiency, combustion: efficiency with which fuel is burned during the combustion process in equipment

Emittance: the ratio of the radiant heat flux emitted by a specimen to that emitted by a blackbody at the same temperature and under the same conditions

Energy: power derived from renewable or non-renewable resources to provide heating, cooling and light to a building or operate any building equipment and appliances. It has various forms such as thermal (heat), mechanical (work), electrical, and chemical that may be transformed from one into another. Customary unit of measurement is watts (W)

Energy Conservation Building Code (ECBC): the Energy Conservation Building Code as updated from time to time by the Bureau and displayed on its website (www.beeindia.gov.in).

Energy Efficiency Ratio (EER): the ratio of net cooling capacity in kW to total rate of electric input in watts under design operating conditions

Energy recovery system: equipment to recover energy from building or space exhaust air and use it to treat (pre-heat or pre-cool) outdoor air taken inside the building or space by ventilation systems

Envelope Performance Factor (EPF): value for the building envelope performance compliance option calculated using the procedures specified in 4.3.5 and 4.3.6. For the purposes of determining building envelope requirements the classifications are defined as follows:

- (a) Standard Building EPF: envelope performance factor calculated for the Standard Building using prescriptive requirements for walls, vertical fenestrations and roofs
- (b) Proposed Building EPF: the building envelope performance factor for the Proposed Building using proposed values for walls, vertical fenestrations and roofs

Energy Performance Index (EPI): of a building means its annual energy consumption in kilowatt-hours per square meter of the area of the building which shall be calculated in the existing or proposed building as per the formula below,

$$= \frac{\text{annual energy consumption in kWh}}{\text{total built – up area (excluding storage area and the parking in the basement) in m}^2}$$

EPI Ratio: of a building means the ratio of the EPI of the Proposed Building to the EPI of the Standard Building.

Equipment: mechanical, electrical or static devices for operating a building, including but not limited to those required for providing cooling, heating, ventilation, lighting, service hot water, vertical circulation

Equipment, existing: equipment previously installed in an existing building

Equivalent SHGC: SHGC for a fenestration with a permanent external shading projection. It is calculated using the Projection Factor (PF) of the permanent external shading projection and Shading Equivalent Factor (SEF) listed in §4.3.1.

Exemption: any exception allowed to compliance with ECBC requirements

F

Fan system power: sum of the nominal power demand (nameplate W or HP) of motors of all fans that are required to operate at design conditions to supply air from the heating or cooling source to the conditioned space(s) and return it to the point where it can be exhausted to outside the building.

Fenestration: all areas (including the frames) in the building envelope that let in light, including windows, plastic panels, clerestories, skylights, glass doors that are more than one-half glass, and glass block walls.

- (a) Skylight: a fenestration surface having a slope of less than 60 degrees from the horizontal plane. Other fenestration, even if mounted on the roof of a building, is considered vertical fenestration.
- (b) Vertical fenestration: all fenestration other than skylights. Trombe wall assemblies, where glazing is installed within 300 mm of a mass wall, are considered walls, not fenestration.

Fenestration area: total area of the fenestration measured using the rough opening and including the glazing, sash, and frame. For doors where the glazed vision area is less than 50% of the door area, the fenestration area is the glazed vision area. For all other doors, the fenestration area is the door area.

Finished floor level: level of floor achieved after finishing materials have been added to the subfloor or rough floor or concrete floor slab.

Fossil fuel: fuel derived from a hydrocarbon deposit such as petroleum, coal, or natural gas derived from living matter of a previous geologic time

Fuel: a material that may be used to produce heat or generate power by combustion

Fuel utilization efficiency (FUE): a thermal efficiency measure of combustion equipment like furnaces, boilers, and water heaters

G

Gathering hall (Type of Assembly): any building, its lobbies, rooms and other spaces connected thereto, primarily intended for assembly of people, but which has no theatrical stage or permanent theatrical and/or cinematographic accessories and has gathering space for greater or equal to 100 persons, for example, stand-alone dance halls, stand-alone night clubs, halls for incidental picture shows, dramatic, theatrical or educational presentation, lectures or other similar purposes having no theatrical stage except a raised platform and used without permanent seating arrangement; art galleries, community halls, marriage halls, places of worship, museums, stand-alone lecture halls, passenger terminals and heritage and archeological monuments, pool and billiard parlors, bowling alleys, community halls, courtrooms, gymnasiums, indoor swimming pools, indoor tennis court, any indoor stadium for sports and culture, auditoriums

Grade: finished ground level adjoining a building at all exterior walls

Guest room: any room or rooms used or intended to be used by a guest for sleeping purposes

H

Habitable spaces: space in a building or structure intended or used for working, meeting, living, sleeping, eating, or cooking. Bathrooms, water closet compartments, closets, halls, storage or utility space, and similar areas are not considered habitable spaces.

Heat capacity: amount of heat necessary to raise the temperature of a given mass by 1°C. Numerically, the heat capacity per unit area of surface ($W/m^2.K$) is the sum of the products of the mass per unit area of each individual material in the roof, wall, or floor surface multiplied by its individual specific heat.

Hospitals and sanatoria (Healthcare): Any building or a group of buildings under single management, which is used for housing persons suffering from physical limitations because of health or age and those incapable of self-preservation, for example, any hospitals, infirmaries, sanatoria and nursing homes.

HVAC system: equipment, distribution systems, and terminal devices that provide, either collectively or individually, the processes of heating, ventilating, or air conditioning to a building or parts of a building.

Hyper Markets (Type F of Shopping Complex): large retail establishments that are a combination of supermarket and department stores. They are considered as a one-stop shop for all needs of the customer.

I

Infiltration: uncontrolled inward air leakage through cracks and crevices in external surfaces of buildings, around windows and doors due to pressure differences across these caused by factors such as wind or indoor and outside temperature differences (stack effect), and imbalance between supply and exhaust air systems

Installed interior lighting power: power in watts of all permanently installed general, task, and furniture lighting systems and luminaires

Integrated part-load value (IPLV): weighted average efficiency of chillers measured when they are operating at part load conditions (less than design or 100% conditions). It is more realistic measurement of chiller efficiency during its operational life.

K

Kilovolt-ampere (kVA): where the term “kilovolt-ampere” (kVA) is used in this Code, it is the product of the line current (amperes) times the nominal system voltage (kilovolts) times 1.732 for three-phase currents. For single-phase applications, kVA is the product of the line current (amperes) times the nominal system voltage (kilovolts).

Kilowatt (kW): the basic unit of electric power, equal to 1000 W.

L

Labeled: equipment or materials to which a symbol or other identifying mark has been attached by the manufacturer indicating compliance with specified standard or performance in a specified manner.

Lamp: a generic term for man-made light source often called bulb or tube

Lighted floor area, gross: gross area of lighted floor spaces

Lighting, emergency: battery backed lighting that provides illumination only when there is a power outage and general lighting luminaires are unable to function.

Lighting, general: lighting that provides a substantially uniform level of illumination throughout an area. General lighting shall not include decorative lighting or lighting that provides a dissimilar level of illumination to serve a specialized application or feature within such area.

Lighting system: a group of luminaires circuited or controlled to perform a specific function.

Lighting power allowance:

- (a) Interior lighting power allowance: the maximum lighting power in watts allowed for the interior of a building
- (b) Exterior lighting power allowance: the maximum lighting power in watts allowed for the exterior of a building

Lighting Power Density (LPD): maximum lighting power per unit area of a space as per its function or building as per its classification.

Low energy comfort systems: space conditioning or ventilation systems that are less energy intensive than vapor compression based space conditioning systems. These primarily employ alternate heat transfer methods or materials (adiabatic cooling, radiation, desiccant, etc.), or renewable sources of energy (solar energy, geo-thermal) so that minimal electrical energy input is required to deliver heating or cooling to spaces.

Luminaires: a complete lighting unit consisting of a lamp or lamps together with the housing designed to distribute the light, position and protect the lamps, and connect the lamps to the power supply.

Luminous Efficacy (LE): total luminous flux (visible light) emitted from a lamp or lamp/ballast combination divided by input power, expressed in lumens per Watt.

M

Man-made daylight obstruction: any permanent man-made object (equipment, adjacent building) that obstructs sunlight or solar radiation from falling on a portion or whole of a building's external surface at any point of time during a year is called as a man-made sunlight obstructor.

Manual (non-automatic): requiring personal intervention for control. Non-automatic does not necessarily imply a manual controller, only that personal intervention is necessary.

Manufacturing processes: processes through which raw material is converted into finished goods for commercial sale using machines, labor, chemical or biological processes, etc.

Manufacturer: company or person or group of persons who produce and assemble goods or purchases goods manufactured by a third party in accordance with their specifications.

Mean temperature: average of the minimum daily temperature and maximum daily temperature.

Mechanical cooling: reducing the temperature of a gas or liquid by using vapor compression, absorption, and desiccant dehumidification combined with evaporative cooling, or another energy-driven thermodynamic cycle. Indirect or direct evaporative cooling alone is not considered mechanical cooling.

Metering: practice of installing meters in buildings to acquire data for energy consumption and other operational characteristics of individual equipment or several equipment grouped on basis of their function (lighting, appliances, chillers, etc.). Metering is done in buildings to monitor their energy performance.

Mixed mode air-conditioned building: building in which natural ventilation is employed as the primary mode of ventilating the building, and air conditioning is deployed as and when required.

Mixed use development: a single building or a group of buildings used for a combination of residential, commercial, business, educational, hospitality and assembly purposes

N

National Building Code 2016 (NBC): model building code that provides guidelines for design and construction of buildings. In this code, National Building Code 2016 refers to the latest version by the Bureau of Indian Standards.

Natural daylight obstruction: any natural object, like tree, hill, etc., that obstructs sunlight from falling on part or whole of a building's external surface at any point of time during a year and casts a shadow on the building surface.

Naturally ventilated building: a building that does not use mechanical equipment to supply air to and exhaust air from indoor spaces. It is primarily ventilated by drawing and expelling air through operable openings in the building envelope.

Non-cardinal directions: any direction which is not a cardinal direction, i.e. perfect north, south, east, or west, is termed as non-cardinal direction.

No Star hotel (Type of Hospitality): any building or group of buildings under the same management, in which separate sleeping accommodation on commercial basis, with or without dining facilities or cooking facilities, is provided for individuals. This includes lodging rooms, inns, clubs, motels, no star hotel and guest houses and excludes residential apartments rented on a lease agreement of 4 months or more. These shall also include any building in which group sleeping accommodation is provided, with or without dining facilities for persons who are not members of the same family, in one room or a series of adjoining rooms under joint occupancy and single management, for example, school and college dormitories, students, and other hostels and military barracks.

O

Occupant sensor: a device that detects the presence or absence of people within an area and causes lighting, equipment, or appliances to be dimmed, or switched on or off accordingly.

Opaque assembly or opaque construction: surface of the building roof or walls other than fenestration and building service openings such as vents and grills.

Opaque external wall: external wall composed of materials which are not transparent or translucent, usually contains the structural part of the building, and supports the glazed façade. This type may be composed of one or more materials, and can accommodate various physical processes at a time, as the insulation and thermal inertia.

Open Gallery Mall (Type of Shopping Complex): a large retail complex containing a variety of stores and often restaurants and other business establishments housed in a series of connected or adjacent buildings or in a single large building. The circulation area and atrium of the open gallery mall is an unconditioned space and is open to sky.

Orientation: the direction a building facade faces, i.e., the direction of a vector perpendicular to and pointing away from the surface of the facade. For vertical fenestration, the two categories are north-oriented and all other.

Outdoor (outside) air: air taken from the outside the building and has not been previously circulated through the building.

Out-patient Healthcare (Type of Healthcare): any building or a group of buildings under single management, which is used only for treating persons requiring treatment or diagnosis of disease but not requiring overnight or longer accommodation in the building during treatment or diagnosis.

Overcurrent: any current in excess of the rated current of the equipment of the ampacity of the conductor. It may result from overload, short circuit, or ground fault.

Owner: a person, group of persons, company, trust, institute, Registered Body, state or central Government and its attached or sub-ordinate departments, undertakings and like agencies or organization in whose name the property stands registered in the revenue records for the construction of a building or building complex

P

Party wall: a firewall on an interior lot line used or adapted for joint service between two buildings.

Permanently installed: equipment that is fixed in place and is not portable or movable.

Plenum: a compartment or chamber to which one or more ducts are connected, that forms a part of the air distribution system, and that is not used for occupancy or storage.

Plug loads: energy used by products that are powered by means of an AC plug. This term excludes building energy that is attributed to major end uses specified in § 5, § 6, § 7 (like HVAC, lighting, water heating, etc.).

Pool: any structure, basin, or tank containing an artificial body of water for swimming, diving, or recreational bathing. The terms include, but no limited to, swimming pool, whirlpool, spa, hot tub.

Potential daylight time: amount of time in a day when there is daylight to light a space adequately without using artificial lighting. Potential daylight time is fixed for 8 hours per day i.e. from 09:00 AM to 5:00 PM local time, resulting 2920 hours in total for all building types except for Type E-1 - Educational, which shall be analyzed for 7 hours per day i.e. from 08:00 AM to 3:00 PM local time.

Primary inter-cardinal direction: any of the four points of the compass, midway between the cardinal points; northeast, southeast, southwest, or northwest are called primary inter-cardinal direction.

Process load: building loads resulting from the consumption or release of energy due to industrial processes or processes other than those for providing space conditioning, lighting, ventilation, or service hot water heating.

Projection factor, overhang: the ratio of the horizontal depth of the external shading projection to the sum of the height of the fenestration and the distance from the top of the fenestration to the bottom of the farthest point of the external shading projection, in consistent units.

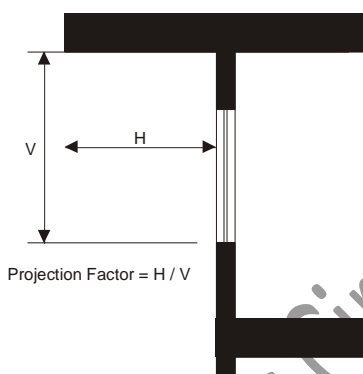

Projection factor, side fin: the ratio of the horizontal depth of the external shading projection to the distance from the window jamb to the farthest point of the external shading projection, in consistent units.

Projection Factor, overhang and side fin: average of ratio projection factor for overhang only and projection factor of side fin only.

Proposed Building: is consistent with the actual design of the building and complies with all the mandatory requirements of ECBC.

Proposed Design: a computer model of the proposed building, consistent with its actual design, which complies with all the mandatory requirements of ECBC.

R

R-value (thermal resistance): the reciprocal of the time rate of heat flow through a unit area induced by a unit temperature difference between two defined surfaces of material or construction under steady-state conditions. Units of R value are $m^2.K / W$.

Readily accessible: capable of being reached quickly for operation, renewal, or inspections without requiring those to whom ready access is requisite to climb over or remove obstacles or to resort to portable ladders, chairs, etc. In public facilities, accessibility may be limited to certified personnel through locking covers or by placing equipment in locked rooms.

Recirculating system: a domestic or service hot water distribution system that includes a close circulation circuit designed to maintain usage temperatures in hot water pipes near terminal devices (e.g., lavatory faucets, shower heads) in order to reduce the time required to obtain hot water when the terminal device valve is opened. The motive force for

circulation is either natural (due to water density variations with temperature) or mechanical (recirculation pump).

Reflectance: ratio of the light or radiation reflected by a surface to the light or radiation incident upon it.

Renewable Energy Generating Zone: a contiguous or semi-contiguous area, either on rooftop or elsewhere within site boundary, dedicated for installation of renewable energy systems.

Resort (Type of Hospitality): commercial establishments that provide relaxation and recreation over and above the accommodation, meals and other basic amenities. The characteristics of resort are as below –

- i. Includes 1 or more recreation(s) facility like spa, swimming pool, or any sport;
- ii. Is located in the midst of natural and picturesque surroundings outside the city;
- iii. Comprises of 2 or more blocks of buildings within the same site less than or equal to 3 floors (including the ground floor).

Reset: automatic adjustment of the controller set point to a higher or lower value.

Roof: the upper portion of the building envelope, including opaque areas and fenestration, that is horizontal or tilted at an angle of less than 60° from horizontal. This includes podium roof as well which are exposed to direct sun rays.

Roof area, gross: the area of the roof measured from the exterior faces of walls or from the centerline of party walls

S

Selectivity ratio of a glass: ratio between light transmission and solar factor of glass.

Service: the equipment for delivering energy from the supply or distribution system to the premises served.

Service water heating equipment: equipment for heating water for domestic or commercial purposes other than space heating and process requirements.

Set point: the desired temperature (°C) of the heated or cooled space that must be maintained by mechanical heating or cooling equipment.

Shading Coefficient (SC): measure of thermal performance of glazing. It is the ratio of solar heat gain through glazing due to solar radiation at normal incidence to that occurring through 3 mm thick clear, double-strength glass. Shading coefficient, as used herein, does not include interior, exterior, or integral shading devices.

Shading Equivalent Factor: coefficient for calculating effective SHGC of fenestrations shaded by overhangs or side fins.

Shopping Mall (Shopping Complex): a large retail complex containing a variety of stores and often restaurants and other business establishments housed in a series of connected or adjacent buildings or in a single large building. The circulation area and atrium of the mall is an enclosed space covered completely by a permanent or temporary structure.

Simulation program: software in which virtual building models can be developed to simulate the energy performance of building systems.

Single-zone system: an HVAC system serving a single HVAC zone.

Site-recovered energy: waste energy recovered at the building site that is used to offset consumption of purchased fuel or electrical energy supplies.

Slab-on-grade floor: floor slab of the building that is in contact with ground and that is either above grade or is less than or equal to 300 mm below the final elevation of the nearest exterior grade.

Soft water: water that is free from dissolved salts of metals such as calcium, iron, or magnesium, which form insoluble deposits on surfaces. These deposits appear as scale in boilers or soap curds in bathtubs and laundry equipment.

Solar energy source: source of thermal, chemical, or electrical energy derived from direction conversion of incident solar radiation at the building site.

Solar Heat Gain Coefficient (SHGC): the ratio of the solar heat gain entering the space through the fenestration area to the incident solar radiation. Solar heat gain includes directly transmitted solar heat and absorbed solar radiation, which is then reradiated, conducted, or convected into the space.

Space: an enclosed area within a building. The classifications of spaces are as follows for purpose of determining building envelope requirements:

- (a) Conditioned space: a cooled space, heated space, or directly conditioned space.
- (b) Semi-heated space: an enclosed space within a building that is heated by a heating system whose output capacity is greater or equal to 10.7 W/m^2 but is not a conditioned space.
- (c) Non-conditioned space: an enclosed space within a building that is not conditioned space or a semi-heated space. Crawlspace, attics, and parking garages with natural or mechanical ventilation are not considered enclosed spaces.

Star Hotels/motels (Star Hotel): any building or group of buildings under single management and accredited as a starred hotel by the Hotel and Restaurant Approval and Classification Committee, Ministry of Tourism, in which sleeping accommodation, with or without dining facilities is provided.

Stand-alone Retail (Shopping Complex): a large retail store owned or sublet to a single management which may offer customers a variety of products under self-branding or products of different brands. The single management shall have a complete ownership of all

the spaces of the building and no space within the building is further sold or sublet to a different management.

Standard Building: a building that minimally complies with all the mandatory and prescriptive requirements of Energy Conservation Building Code and has same floor area, gross wall area, and gross roof area of the Proposed Building.

Standard Design: a computer model of a hypothetical building, based on actual building design, that fulfils all the mandatory requirements and minimally complies with the prescriptive requirements of ECBC, as described in the Whole Building Performance method.

Story: portion of a building that is between one finished floor level and the next higher finished floor level or building roof. Basement and cellar shall not be considered a story.

Summer Solar Insolation: measure of solar radiation energy received on a given surface area from the month of March to October within the same calendar year. Units of measurement are watts per square meter (W/m^2) or kilowatt-hours per square meter per day ($kW \cdot h / (m^2 \cdot \text{day})$) (or hours/day).

SuperECBC Building: a building that complies with the mandatory requirements of §4 to §7 and also complies either with the prescriptive requirements stated under the SuperECBC Building categories of §4 to §7, or, with the whole building performance compliance method of §9. This is a voluntary level of compliance with ECBC.

Super Market (Shopping Complex): supermarkets are large self-service grocery stores that offer customers a variety of foods and household supplies. The merchandise is organized into an organized aisle format, where each aisle has only similar goods placed together.

System: a combination of equipment and auxiliary devices (e.g., controls, accessories, interconnecting means, and terminal elements) by which energy is transformed so it performs a specific function such as HVAC, service water heating, or lighting.

System Efficiency: the system efficiency is the ratio of annual kWh electricity consumption of equipment of water cooled chilled water plant (i.e. chillers, chilled and condenser water pumps, cooling tower) to chiller thermal kWh used in a building.

System, existing: a system or systems previously installed in an existing building.

T

Tenant lease agreement: The formal legal document entered into between a Landlord and a Tenant to reflect the terms of the negotiations between them; that is, the lease terms have been negotiated and agreed upon, and the agreement has been reduced to writing. It constitutes the entire agreement between the parties and sets forth their basic legal rights.

Tenant leased area: area of a building that is leased to tenant(s) as per the tenant lease agreement.

Terminal device: a device through which heated or cooled air is supplied to a space to maintain its temperature. It usually contains dampers and heating and cooling coils. Or a device by which energy from a system is finally delivered, e.g., registers, diffusers, lighting fixtures, faucets, etc.

Theater or motion picture hall (Type of Assembly): any building primarily meant for theatrical or operatic performances and which has a stage, proscenium curtain, fixed or portable scenery or scenery loft, lights, mechanical appliances or other theatrical accessories and equipment for example, theaters, motion picture houses, auditoria, concert halls, television and radio studios admitting an audience and which are provided with fixed seats.

Thermal block: a collection of one or more HVAC zones grouped together for simulation purposes. Spaces need not be contiguous to be combined within a single thermal block.

Thermal comfort conditions: conditions that influence thermal comfort of occupants. Environmental conditions that influence thermal comfort air and radiant temperature, humidity, and air speed.

Thermostat: device containing a temperature sensor used to automatically maintain temperature at a desirable fixed or adjustable set point in a space.

Tinted: (as applied to fenestration) bronze, green, or grey coloring that is integral with the glazing material. Tinting does not include surface applied films such as reflective coatings, applied either in the field or during the manufacturing process.

Transformer: a piece of electrical equipment used to convert electric power from one voltage to another voltage.

Transformer losses: electrical losses in a transformer that reduces its efficiency.

Transport Buildings (Assembly): any building or structure used for the purpose of transportation and transit like airports, railway stations, bus stations, and underground and elevated mass rapid transit system example, underground or elevated railways.

U

Unconditioned buildings: building in which more than 90% of spaces are unconditioned spaces.

Unconditioned space: mechanically or naturally ventilated space that is not cooled or heated by mechanical equipment.

Universities and all others coaching/training institutions (Educational): a building or a group of buildings, under single management, used for imparting education to students numbering more than 100 or public or private training institution built to provide training/coaching etc.

Useful Daylight Illuminance: percentage of annual daytime hours that a given point on a work plane height of 0.8 m above finished floor level receives daylight between 100 lux to 2,000 lux.

U-factor (Thermal Transmittance): heat transmission in unit time through unit area of a material or construction and the boundary air films, induced by unit temperature difference between the environments on each side. Unit of U value is $W/m^2.K$.

V

Variable Air Volume (VAV) system: HVAC system that controls the dry-bulb temperature within a space by varying the volumetric flow of heated or cooled air supplied to the space

Vegetative roofs: also known as green roofs, they are thin layers of living vegetation installed on top of conventional flat or sloping roofs.

Ventilation: the process of supplying or removing air by natural or mechanical means to or from any space. Such air is not required to have been conditioned.

Vision Windows: windows or area of large windows that are primarily for both daylight and exterior views. Typically, their placement in the wall is between 1 meter and 2.2 meter above the floor level.

W

Wall: that portion of the building envelope, including opaque area and fenestration, that is vertical or tilted at an angle of 60° from horizontal or greater. This includes above- and below-grade walls, between floor spandrels, peripheral edges of floors, and foundation walls.

- (a) Wall, above grade: a wall that is not below grade
- (b) Wall, below grade: that portion of a wall in the building envelope that is entirely below the finish grade and in contact with the ground

Wall area, gross: the overall area off a wall including openings such as windows and doors measured horizontally from outside surface to outside service and measured vertically from the top of the floor to the top of the roof. If roof insulation is installed at the ceiling level rather than the roof, then the vertical measurement is made to the top of the ceiling. The gross wall area includes the area between the ceiling and the floor for multi-story buildings.

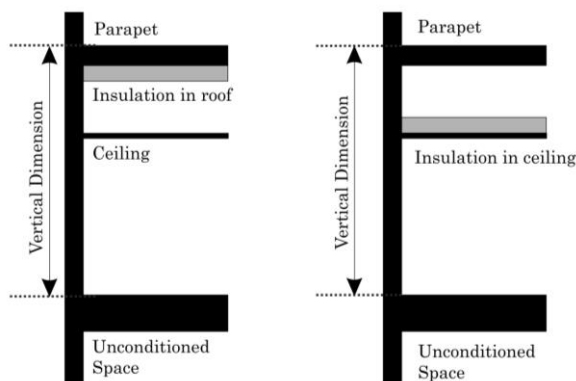

Water heater: vessel in which water is heated and withdrawn for use external to the system.

Z

Zone, HVAC: a space or group of spaces within a building with heating and cooling requirements that are sufficiently similar so that desired conditions (e.g., temperature) can be maintained throughout using a single sensor (e.g., thermostat or temperature sensor).

8.3 SI to IP Conversion Factors

SI Unit	IP Unit
1 cmh	1.7 cfm
1 Pa	0.0040 inch of water gauge
1m	3.28 ft
1m	39.37 in
1mm	0.039 in
1 l/s	2.12 cfm
1 m ²	10.76 ft ²
1 W/m ²	10.76 W/ ft ²
1 W/ lin m	3.28 W/ ft
1 W/m ² .K	5.678 Btu/ h-ft ² -°F
1 W/ l-s ⁻¹	0.063 W/ gpm
1 m ² .KW	0.1761 ft ² -h-°F/ Btu
1 °C	((°C X 9/5) + 32) °F
1 kW _r	0.284 TR
1 kW	1.34 hp
1 kW	3412.142 Btu/hr

8.4 Abbreviations and Acronyms

AFUE	Annual fuel utilization efficiency
AHRI	Air-conditioning, Heating and Refrigeration Institute
ANSI	American National Standards Institute
ARI	Air-Conditioning and Refrigeration Institute
ASHRAE	American Society of Heating, Refrigerating and Air-Conditioning Engineers
ASTM	American Society for Testing and Materials
BIS	Bureau of Indian Standards
Btu	British thermal unit
Btu/h	British thermal units per hour
Btu/h-ft ² -°F	British thermal units per hour per square foot per degree Fahrenheit
BUA	Built up area
C	Celsius
cmh	cubic meter per hour
cm	centimeter
COP	coefficient of performance
DEF	daylight extent factor
EER	energy efficiency ratio
EPI	energy performance index
F	Fahrenheit
ft	foot
h	hour
h-ft ² -°F/Btu	hour per square foot per degree Fahrenheit per British thermal unit
h-m ² -°C/W	hour per square meter per degree Celsius per Watt
hp	horsepower
HVAC	heating, ventilation, and air conditioning
I-P	inch-pound
in.	inch
IPLV	integrated part-load value
IS	Indian Standard
ISO	International Organization for Standardization
kVA	kilovolt-ampere
kW	Kilowatt of electricity
kW _r	kilowatt of refrigeration
kWh	kilowatt-hour
l/s	liter per second

LE	luminous efficacy
lin	linear
lin ft	linear foot
lin m	linear meter
lm	lumens
Lm/W	lumens per watt
LPD	lighting power density
m	meter
mm	millimeter
m ²	square meter
m ² .K/W	square meter Kelvin per watt
NBC	National Building Code 2016
Pa	pascal
PF	projection factor
R	R-value (thermal resistance)
SC	shading coefficient
SEF	Shading equivalent factor
SHGC	solar heat gain coefficient
TR	tons of refrigeration
UPS	uninterruptible power supply
VAV	variable air volume
VLT	visible light transmission
W	watt
W/ l-s ⁻¹	watt per litre per second
W/m ²	watts per square meter
W/m ² .K	watts per square meter per Kelvin
W/m ²	watts per hour per square meter
W/m.K	watts per lineal meter per Kelvin
Wh	watthour

9 Whole Building Performance Method

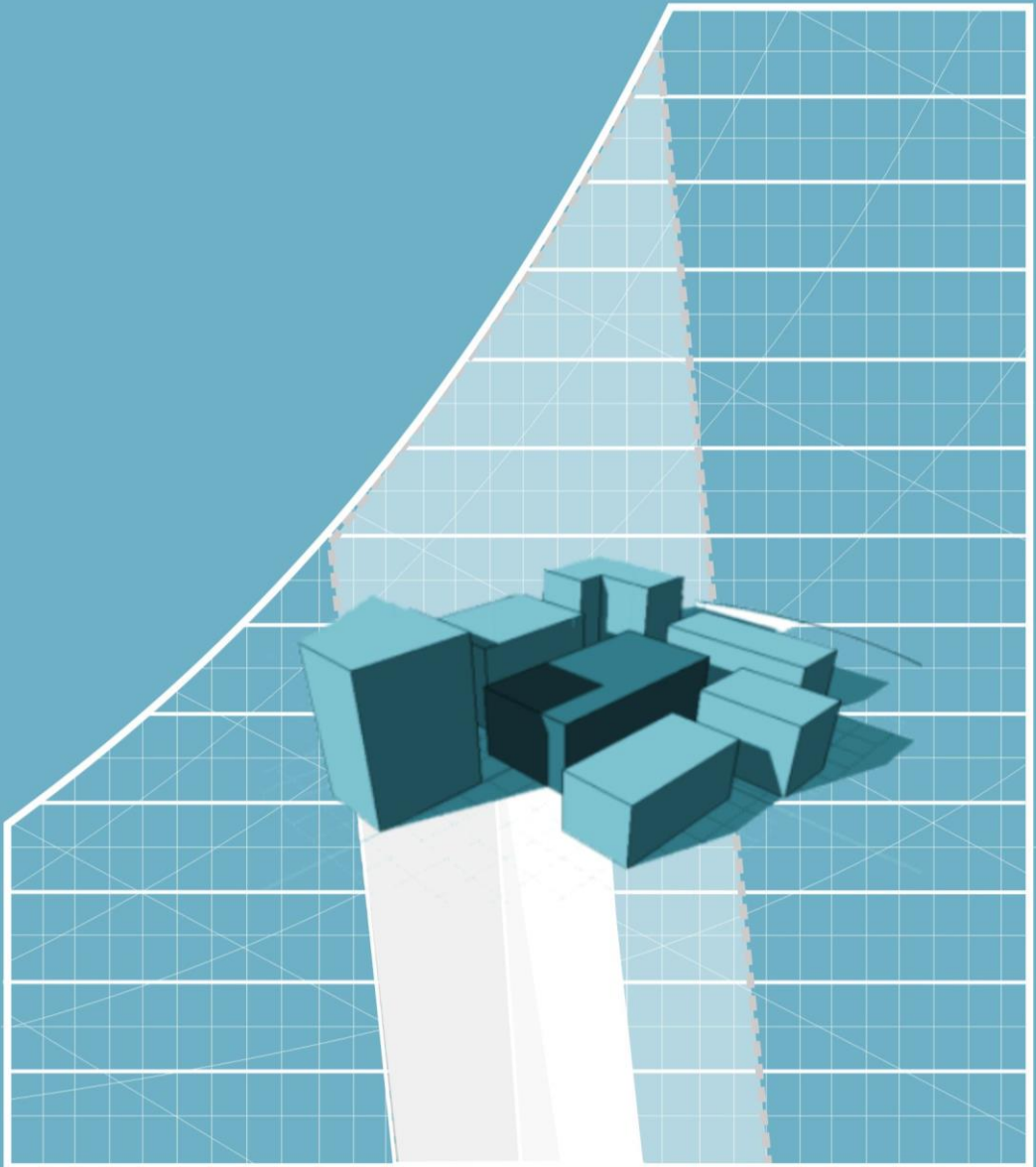

9. Whole Building Performance Method

9.1 General

9.1.1 Scope

The Whole Building Performance Method is an alternative to the Prescriptive Method compliance path contained in §4 through §7 of this Code. It applies to all building types covered by the Code as mentioned in §2.5.

9.1.2 Compliance

A building complies with the Code using the Whole Building Performance (WBP) Method, when the estimated EPI Ratio is equal to or less than 1, even though it may not comply with the specific provisions of the prescriptive requirements in §4 through §7. The mandatory requirements of §4 through §7 (§4.2, §5.2, §6.2, and §7.2) shall be met when using the WBP Method.

9.1.3 Annual Energy Use

Annual energy use for the purposes of the WBP Method shall be calculated in kilowatt-hours (kWh) of electricity use per year per unit area. Energy sources other than electricity that are used in the building shall be converted to kWh of electric energy at the rate of 0.75 kWh per megajoule.

Note: *The annual energy use calculation as per the Whole Building Performance Method is not a prediction of the actual energy use of the building once it gets operational. Actual energy performance of a building depends on a number of factors like weather, occupant behaviour, equipment performance and maintenance, among others, which are not covered by this Code.*

9.1.4 Trade-offs Limited to Building Permit

The WBP Method may be used for building permit applications that include less than the whole building; however, any design parameters that are not part of the building permit application shall be identical for both the Proposed Design and the Standard Design. Future improvements to the building shall comply with both the mandatory and prescriptive requirements of concurrent code.

9.1.5 Documentation Requirements

Compliance shall be documented and compliance forms shall be submitted to the authority having jurisdiction. The information submitted shall include, at a minimum, the following:

- (a) Summary describing the results of the analysis, including the annual energy use for the Proposed Design and the Standard Design, and software used.
- (b) Brief description of the project with location, number of stories, space types, conditioned and unconditioned areas, hours of operation.
- (c) List of the energy-related building features of the Proposed Design. This list shall also document features different from the Standard Design.
- (d) List showing compliance with the mandatory requirements of this code.
- (e) The input and output report(s) from the simulation program including a breakdown of energy usage by at least the following components: lights, internal equipment loads, service water heating equipment, space heating equipment, space cooling and heat rejection equipment, fans, and other HVAC equipment (such as pumps). The output reports shall also show the number of hours any loads are not met by the HVAC system for both the Proposed Design and Standard Design.
- (f) Explanation of any significant modelling assumptions made.
- (g) Explanation of any error messages noted in the simulation program output.
- (h) Building floor plans, building elevations, and site plan.

9.2 Mandatory Requirements

All requirements of §4.2, §5.2, §6.2, and §7.2 shall be met. These sections contain the mandatory provisions of the Code and are prerequisites for demonstrating compliance using the WBP Method.

9.3 Simulation Requirements

9.3.1 Energy Simulation Program

The simulation software shall be a computer-based program for the analysis of energy consumption in buildings and be approved by the authority having jurisdiction. The simulation program shall, at a minimum, have the ability to model the following:

- (a) Energy flows on an hourly basis for all 8,760 hours of the year,
- (b) Hourly variations in occupancy, lighting power, miscellaneous equipment power, thermostat set points, and HVAC system operation, defined separately for each day of the week and holidays,
- (c) Thermal mass effects,
- (d) Ten or more thermal zones,
- (e) Part-load and temperature dependent performance of heating and cooling equipment,
- (f) Air-side and water-side economizers with integrated control.

In addition to the above, the simulation tool shall be able to produce hourly reports of

energy use by energy source and shall have the capability to performing design load calculations to determine required HVAC equipment capacities, air, and water flow rates in accordance with §5 for both the proposed and Standard building designs.

The simulation program shall be tested according to ASHRAE Standard 140 Method of Test for the Evaluation of Building Energy Analysis Computer Programs (ANSI approved) and the results shall be furnished by the software provider.

9.3.2 Climate Data

The simulation program shall use hourly values of climatic data, such as temperature and humidity, from representative climatic data for the city in which the Proposed Design is to be located. For cities or urban regions with several climate data entries, and for locations where weather data are not available, the designer shall select available weather data that best represent the climate at the construction site.

9.3.3 Compliance Calculations

The Proposed Design and Standard Design shall be calculated using the following:

- (a) Same simulation program,
- (b) Same weather data, and
- (c) Identical building operation assumptions (thermostat set points, schedules, equipment and occupant loads, etc.) unless an exception is allowed by this Code or the authority having jurisdiction for a given category.

9.4 Calculating Energy Consumption of Proposed Design and Standard Design

9.4.1 Energy Simulation Model

The simulation model for calculating the Proposed Design and the Standard Design shall be developed in accordance with the requirements in Table 9-1. The Standard Design is based on the mandatory and prescriptive requirements of the ECBC compliant building. The Standard Design will be the same for all compliance levels (ECBC, ECBC+, Super ECBC).

9.4.2 HVAC Systems

The HVAC system type and related performance parameters for the Standard Design shall be determined from Table 9-2 and the following rules:

- (a) Other components: Components and parameters not listed in Table 9-2 or otherwise specifically addressed in this subsection shall be identical to those in the Proposed Design.

Exception to § 9.4.2(a): Where there are specific requirements in §5.2.2, the component efficiency in the Standard Design shall be adjusted to the lowest efficiency level allowed by the requirement for that component type.

- (b) All HVAC and service water heating equipment in the Standard Design shall be modeled at the minimum efficiency levels, both part load and full load, in accordance with §5.2.2.
- (c) Where efficiency ratings, such as EER and COP, include fan energy, the descriptor shall be broken down into its components so that supply fan energy can be modeled separately.
- (d) Minimum outdoor air ventilation rates shall be the same for both the Standard Design and the Proposed Design except for conditions specified in §9.4.2.1.
- (e) The equipment capacities for the Standard Design shall be sized proportionally to the capacities in the Proposed Design based on sizing runs; i.e., the ratio between the capacities used in the annual simulations and the capacities determined by the sizing runs shall be the same for both the Proposed Design and Standard Design.
- (f) Unmet load hours for the Proposed Design shall not differ from unmet load hours for the Standard Design by more than 50 hours. Maximum number of unmet hours shall not exceed 300 for either case.

Table 9-1 Modelling Requirements for Calculating Proposed and Standard Design

Case	Proposed Design	Standard Design
1. Design Model	<p>(a) The simulation model of the Proposed Design shall be consistent with the design documents, including proper accounting of fenestration and opaque envelope types and area; interior lighting power and controls; HVAC system types, sizes, and controls; and service water heating systems and controls.</p> <p>(b) When the whole building performance method is applied to buildings in which energy-related features have not been designed yet (e.g., a lighting system), those yet-to-be-designed features shall be described in the Proposed Design so that they minimally comply with applicable mandatory and prescriptive requirements of §4.2, §5.2, §6.2, and §7.2 and §4.3, §5.3, and §6.3 respectively.</p>	<p>The Standard Design shall be developed by modifying the Proposed Design as described in this table. Unless specified in this table, all building systems and equipment shall be modeled identically in the Standard Design and Proposed Design.</p>
2. Space Use Classification	<p>The building type or space type classifications shall be chosen in accordance with §2.5. More than one building type category may be used in a building if it is a mixed-use facility.</p>	<p>Same as Proposed Design.</p>
3. Schedules	<p>Operational schedules (hourly variations in occupancy, lighting power, equipment power, HVAC equipment operation, etc.) suitable for the building and/or space type shall be modeled for showing compliance.</p>	<p>Same as Proposed Design. Exception: Schedules may be allowed to differ between the Standard and Proposed models wherever it is necessary to model nonstandard efficiency</p>

Schedules must be modeled as per §9.6. In case a schedule for an occupancy type is missing in §9.6, appropriate schedule may be used. Temperature and humidity schedules and set points shall be identical in the Standard and Proposed Designs. Temperature control/thermostat throttling ranges shall also be modeled identically in both the Designs.

measures and/or measures which can be best approximated by a change in schedule. Measures that may warrant a change in operating schedules include but are not limited to automatic controls for lighting, natural ventilation, demand controlled ventilation systems, controls for service water heating load reduction. Schedule change is not allowed for manual controls under any category. This is subject to approval by the authority having jurisdiction.

4. Building Envelope

All components of the building envelope in the Proposed Design shall be modeled as shown on architectural drawings or as installed for existing building envelopes. Exceptions: The following building elements are permitted to differ from architectural drawings.

(a) Any envelope assembly that covers less than 5% of the total area of that assembly type (e.g., exterior walls) need not be separately described. If not separately described, the area of an envelope assembly must be added to the area of the adjacent assembly of that same type.

(b) Exterior surfaces whose azimuth orientation and tilt differ by no more than 45 degrees and are otherwise the same may be described as either a single surface or by using multipliers.

(c) For exterior roofs, other than roofs with ventilated attics, the reflectance and emittance of the roof surface shall be modeled in accordance with §4.3.1.1.

(d) Manually operated fenestration shading devices such as blinds or shades shall not be modeled. Permanent shading devices such as fins, overhangs, and light shelves shall be modeled.

(e) The exterior roof surface shall be modeled using the solar reflectance in accordance with ASTM E903-96 and thermal emittance determined in accordance with ASTM E408-71. Where cool roof is proposed, emittance and reflectance shall be modeled as per ASTM E408-71 and ASTM E903-96 respectively. Where cool roof is not proposed, the exterior roof surface shall be modeled with a reflectance of 0.3 and a thermal emittance of 0.9.

The Standard Design shall have identical conditioned floor area and identical exterior dimensions and orientations as the Proposed Design, except as noted in (a), (b), (c), and (d) below.

(a) Orientation. The Standard Design performance shall be generated by simulating the building with its actual orientation and again after rotating the entire building 90, 180, 270 degrees, then averaging the results. The building shall be modeled so that it does not shade itself.

(b) Opaque assemblies such as roof, floors, doors, and walls shall be modeled as having the same heat capacity as the Proposed Design but with the maximum U-factor allowed in §4.3.1 and §4.3.1.1.

(c) Fenestration. Fenestration areas shall equal that in the Proposed Design or 40% of gross above grade wall area, whichever is smaller, and shall be distributed on each face in the same proportions as in the Proposed Design. No shading projections are to be modeled; fenestration shall be assumed to be flush with the exterior wall or roof. Manually operated fenestration shading devices such as blinds or shades shall not be modeled. Fenestration U-factor shall be the maximum allowed for the climate, and the solar heat gain coefficient shall be the maximum allowed for the climate and orientation.

(d) Roof Solar Reflectance and Thermal Emittance: The exterior roof surfaces shall be modeled using a solar reflectance of 0.6 and a thermal emittance of 0.9.

5. Lighting

Lighting power in the Proposed Design shall be determined as follows:

Where a complete lighting system exists, the actual lighting power shall be used in the model.

Where a lighting system has been designed, lighting power shall be determined in accordance with either §6.3.4.

Where no lighting exists, or is specified, lighting power shall be determined in accordance with the §6.3.2 or §6.3.3 for the appropriate building type.

Lighting system power shall include all lighting system components shown or provided for on plans (including lamps, ballasts, task fixtures, and furniture-mounted fixtures).

Lighting power for parking garages and building facades shall be modeled.

Minimum Lighting controls, as per the ECBC requirements of §6.2.1, shall be modeled in the Proposed case.

Automatic daylighting controls shall be modeled directly in the software or through schedule adjustments determined by a separate daylight analysis approved by the authority having jurisdiction.

Other automatic lighting controls shall be modeled directly in the software by adjusting the lighting power as per Table 9-4.

Lighting power in the Standard Design shall be determined using the same categorization procedure (building area or space function) and categories as the Proposed Design with lighting power set equal to the maximum allowed for the corresponding method and category in either §6.3.2 or §6.3.3. Power for fixtures not included in the lighting power density calculation shall be modeled identically in the Proposed Design and Standard Design. Lighting controls shall be as per the ECBC requirements of §6.2.1.

6. HVAC Thermal Zones

HVAC Zones Designed: Where HVAC zones are defined on design drawings, each HVAC zone shall be modeled as a separate thermal block.

Exception: Identical zones (similar occupancy and usage, similar internal loads, similar set points and type of HVAC system, glazed exterior walls face the same orientation or vary by less than 45°) may be combined for simplicity.

HVAC Zones Not Designed: Where HVAC zones are not defined on design drawings, HVAC zones shall be defined based on similar occupancy and usage, similar internal loads, similar set points and type of HVAC system, glazed exterior walls that face the same orientation or vary by less than 45° in combination with the following rules:

Perimeter Core Zoning: Separate thermal block shall be modeled for perimeter and core spaces. Perimeter spaces are defined

Same as Proposed Design

as spaces located within 5 meters of an exterior or semi exterior wall. Core spaces are defined as spaces located greater than 5 meters of an exterior or semi exterior wall. Separate thermal blocks shall be modeled for floors in contact with ground and for floors which have a ceiling/roof exposure to the ambient.

The HVAC system type and all related performance parameters, such as equipment capacities and efficiencies, in the Proposed Design shall be determined as follows:

(a) Where a complete HVAC system exists, the model shall reflect the actual system type using actual component capacities and efficiencies.

(b) Where an HVAC system has been designed, the HVAC model shall be consistent with design documents.

Mechanical equipment efficiencies shall be adjusted from actual design conditions to the rating conditions specified in §5, if required by the simulation model.

(c) Where no heating system has been specified, the heating system shall be assumed to be electric. The system characteristics shall be identical to the system modeled in the Standard Design.

(d) Where no cooling system has been specified, the cooling system and its characteristics shall be identical to the system modeled in the Standard Design.

The HVAC system type shall be as per Table 9-2 and related performance parameters for the Standard Design shall be determined from requirements of §9.4.2. Equipment performance shall meet the requirements of §5 for code compliant building.

7.

HVAC Systems

The service hot water system type and all related performance parameters, such as equipment capacities and efficiencies, in the Proposed Design shall be determined as follows:

(a) Where a complete service hot water system exists, the model shall reflect the actual system type using actual component capacities and efficiencies.

(b) Where a service hot water system has been designed, the service hot water model shall be consistent with design documents.

(c) Where no service hot water system exists, or is specified, no service hot water heating shall be modeled.

The service water heating system shall be of the same type as the Proposed Design. For residential facilities, hotels and hospitals the Standard Design shall have a solar hot water system capable of meeting 20% of the hot water demand. Systems shall meet the efficiency requirements of §5.2.9.2, the pipe insulation requirements of §5.2.9.4 and incorporate heat traps in accordance with §5.2.9.5.

8.

Service Hot Water

Receptacle, motor, and process loads shall be modeled and estimated based on the building type or space type category. These loads shall be included in simulations of the building and shall be included when

Receptacle, motor and process loads shall be modeled the same as the Proposed Design.

9.

Miscellaneous Loads

calculating the Standard Design and Proposed Design. All end-use load components within and associated with the building shall be modeled, unless specifically excluded by this Table, but not limited to, exhaust fans, parking garage ventilation fans, exterior building lighting, swimming pool heaters and pumps, elevators and escalators, refrigeration equipment, and cooking equipment.

10.
Modelling
Limitations to
the Simulation
Program

If the simulation program cannot model a component or system included in the Proposed Design, one of the following methods shall be used with the approval of the authority having jurisdiction: Same as Proposed Design.

(a) Ignore the component if the energy impact on the trade-offs being considered is not significant.

(b) Model the component substituting a thermodynamically similar component model.

(c) Model the HVAC system components or systems using the HVAC system of the Standard Design in accordance with Section 6 of this table.

Whichever method is selected, the component shall be modeled identically for both the Proposed Design and Standard Design models.

Table 9-2 HVAC Systems Map for Standard Design

	Hotel/Motel, Hospital Patient Rooms, Hotel Guest Rooms, Resorts, Villas, Sleeping Quarters in Mixed-use Buildings, Schools, Classrooms/Lecture Rooms ¹	Buildings with Less than or Equal to 12,500 m ² of Conditioned Area	Buildings with More than 12,500 m ² of Conditioned Area	Data Centre/ Server/Computer Rooms
Name	System A	System B	System C	System D
System Type ²	Split AC	VRF : Variable Refrigerant Flow	VAV: Central cooling plant with variable volume AHU for each zone	Computer Room air conditioners
Fan Control	Constant Volume	Constant volume	Variable volume	Constant volume
Cooling Type	Direct expansion with air cooled condenser	Direct expansion with air cooled condenser	Chilled Water with water cooled condenser	Direct expansion with air cooled condenser
Heating Type	1. Heat Pump: Where no heating system has been specified or where an electric heating system has been specified in the Proposed Design 2. Fossil Fuel Boiler: Where a heating system exists and a fossil fuel hot water boiler has been specified in the Proposed Design	1. Heat Pump: Where no heating system has been specified or where an electric heating system has been specified in the Proposed Design 2. Fossil Fuel Boiler: Where a heating system exists and a fossil fuel hot water boiler has been specified in the Proposed Design	1. Electric resistance: Where no heating system has been specified or where an electric heating system has been specified in the Proposed Design 2. Fossil Fuel Boiler: Where a heating system exists and a fossil fuel hot water boiler has been specified in the Proposed Design	NA

Notes:

- Buildings of the listed occupancy types or spaces in Mixed-use Buildings with the listed occupancy types.
- Where attributes make a building eligible for more than one system type; use the predominant condition to determine the Standard Design system type provided the non-predominant conditions apply to less than 1,000 m² of conditioned floor area. Use additional system type for non-predominant conditions if those conditions apply to more than 1,000 m² of conditioned floor area. Use additional system type for any space which has a substantial difference in peak loads and/or operational hours compared to the predominant space type. Such spaces may include but are not limited to computer/server rooms, retail areas in residential, or office buildings.

9.4.2.1 Minimum Outdoor air rates:

Minimum outdoor air rates shall be identical for both the Standard Design and Proposed Design, except

- (a) when modeling demand controlled ventilation (DCV) in the Proposed Design (DCV is not required in the Standard Design as per §5.2.1.4)
- (b) when the Proposed Design has a minimum ventilation flow higher than the minimum required by the applicable code, the Standard Design shall be modeled as per the minimum ventilation rate required by the applicable code and the Proposed Design shall be modeled as per actual design (higher than Standard Design)

9.4.2.2 Fan Schedules

Supply and return fans shall operate continuously whenever the spaces are occupied and shall be cycled to meet heating and cooling loads during unoccupied hours.

9.4.2.3 Fan Power

- (a) For Systems Types A, B and D,

$$P_{fan} = cmh \times .51$$

Where P_{fan} = Standard Design fan power in watts

cmh = Standard Design supply airflow rate auto-sized by the simulation software

- (b) For System Type C

Fan power shall be modeled as per power and efficiency limits specified in Table 5-12 using a static pressure of 622 Pa or the design static pressure, whichever is higher. The simulation software shall automatically calculate the Standard Design fan power based on the above inputs.

9.4.2.4 Design Airflow Rates

Design airflow rates for the Standard Design shall be sized based on a supply air to room air temperature difference of 11 °C. The Proposed Design airflow rates shall be as per design.

9.4.2.5 Economizers (airside and waterside)

Airside economizers shall be modeled in the Standard Design as per the requirements of §5.3.3.

Exception to §9.4.2.5: Airside economizer shall not be modeled for Standard Design HVAC System Type A.

9.4.2.6 Energy Recovery

Energy recovery shall be modeled in the Standard Design as per the requirements of §5.3.

9.4.2.7 Chilled Water Design Supply Temperatures

Chilled water design supply temperature shall be modeled at 6.7° C and return temperature at 13.3° C.

9.4.2.8 Chillers

Only electric chillers shall be modeled in the Standard Design for System C. Chillers shall meet the minimum efficiency requirements indicated in Table 5-1 and Table 5-2. Chillers in the Standard Design shall be selected as per Table 9-3 below:

Table 9-3 Modeling Requirements for Calculating Proposed and Standard Design

Peak Building Cooling Load (kW_r)	Chiller Type
< 1,055	1 Water Cooled Screw Chiller
1,055 to 2,110	2 Water Cooled Screw Chillers
> 2,110	2 Water Cooled Centrifugal Chillers minimum, equally sized such that no Chiller is greater than 2,813 kW_r

Exception to above: Air cooled chillers are allowed to be modeled in the Standard Design if the Proposed Design has air cooled chillers. If the proposed building has a mix of air and water cooled chillers, then the Standard Design shall be modeled with a mix of air and water cooled chillers in the same proportion as in the Proposed Design. However, this exception applies only for minimum ECBC compliance. Air cooled chillers shall not be modeled in the Standard Design when demonstrating compliance with ECBC+ and SuperECBC Building requirements.

9.4.2.9 Chilled Water Pumps

Chilled and condenser water pumps for the Standard Design shall be modeled as per power and efficiency limits specified in Table 5-15.

Standard Design chilled water pumps shall be modeled as primary-secondary with variable secondary flow.

9.4.2.10 Cooling Tower

Standard Design cooling tower shall be modeled as an open circuit axial flow tower with power and efficiency as per Table 5-18. The fans shall be modeled as two speed.

Condenser water design supply temperature shall be 29.4°C or 5.6°C approach to wet bulb temperature, whichever is lower, with a design temperature rise of 5.6°C.

9.4.2.11 Boiler

Standard Design boilers shall be modeled as natural draft boilers and shall use the same fuel as the Proposed Design. Boiler efficiency shall be modeled as per Table 5-19.

9.4.2.12 Hot Water Design Supply Temperatures

Hot water design supply temperature shall be modeled at 82°C and return temperature at 54°C.

9.4.2.13 Hot Water Pumps

The Standard Design hot water pumps shall be modeled with a minimum efficiency of 70% and a pump power of 300 W/l-s⁻¹.

Standard Design hot water pumps shall be modeled as primary-secondary with variable secondary flow.

9.4.2.14 Campus/District Cooling Systems

All district cooling plants shall be assumed to be on grid electricity, unless otherwise specified and supported through pertinent documents. New district plants shall comply with the mandatory requirements of ECBC irrespective of who owns and/or operates the district plant.

Projects may choose either option A or option B given below for modelling campus/district cooling systems.

Option A

The cooling source shall be modeled as purchased chilled water in both the Standard Design and Proposed Design. For the Standard Design, Table 9-2 HVAC Systems Map, shall be modified as follows:

- a) For System Type C; purchased chilled water shall be modeled as the cooling source.
- b) System Types A and B shall be replaced with a two-pipe fan coil system with purchased chilled water as the cooling source.

The chilled water/thermal energy consumption simulated by the software shall be converted to units of kWh and added to the overall building energy consumption. The following conversion factors shall be used to convert chilled water/thermal energy consumption to units of kWh.

$$1 \text{ ton hour} = 0.85 \text{ kWh}$$

$$1 \text{ MBtu} = 1,000,000 \text{ Btu} = 293 \text{ kWh}$$

Option B

The Standard Design shall be modeled as per Table 9-2 HVAC Systems Map.

For the Proposed Design, model a virtual onsite chilled water plant with Chiller, Pumps and cooling towers modeled at minimum efficiency levels as per §9.4.2.7 to §9.4.2.10. Airside/low side capacities shall be modeled as per design and the plant capacities shall be auto-sized by the software.

Table 9-4 Power Adjustment Factors for Automatic Lighting Controls

<i>Automatic Control Device</i>	<i>Daytime occupancy and area <300 m²</i>	<i>All Others</i>
Programmable Timing Control	10%	0%
Occupancy Sensor	10%	10%
Occupancy Sensor and Programmable Timing Control	15%	10%

9.4.3 Compliance Thresholds for ECBC compliant, ECBC+ and SuperECBC Buildings

For buildings to qualify as ECBC+ and SuperECBC Buildings, the WBP Method shall be followed for the Standard Design as detailed above. The Proposed Design for ECBC+ and SuperECBC Buildings shall meet the mandatory provisions of §4.2, §5.2, §6.2, and §7.2.

The EPI Ratio for ECBC+ and SuperECBC Buildings shall be equal to or less than the EPI Ratios listed under the applicable climate zone in Table 9-5 through Table 9-9 of §9.5.

9.5 Maximum Allowed EPI Ratios

Table 9-5 Maximum Allowed EPI Ratios for Building in Composite Climate

Building Type	Composite		
	ECBC	ECBC+	SuperECBC
Hotel (No Star and Star)	1	0.91	0.81
Resort	1	0.88	0.76
Hospital	1	0.85	0.77
Outpatient	1	0.85	0.75
Assembly	1	0.86	0.77
Office (Regular Use)	1	0.86	0.78
Office (24Hours)	1	0.88	0.76
Schools and University	1	0.77	0.66
Open Gallery Mall	1	0.85	0.76
Shopping Mall	1	0.86	0.74
Supermarket	1	0.81	0.70
Strip retail	1	0.82	0.68

Table 9-6 Maximum Allowed EPI Ratios for Buildings in Hot and Dry Climate

Building Type	Hot and Dry		
	ECBC	ECBC+	SuperECBC
Hotel (No Star and Star)	1	0.90	0.81
Resort	1	0.88	0.76
Hospital	1	0.84	0.76
Outpatient	1	0.85	0.75
Assembly	1	0.86	0.78
Office (Regular Use)	1	0.86	0.78
Office (24Hours)	1	0.88	0.76
Schools and University	1	0.77	0.66
Open Gallery Mall	1	0.85	0.77
Shopping Mall	1	0.84	0.72
Supermarket	1	0.73	0.69
Strip retail	1	0.82	0.68

Table 9-7 Maximum Allowed EPI Ratios for Buildings in Temperate Climate

Building Type	Temperate		
	ECBC	ECBC+	SuperECBC
Hotel (No Star and Star)	1	0.90	0.80
Resort	1	0.88	0.75
Hospital	1	0.82	0.73
Outpatient	1	0.85	0.75
Assembly	1	0.85	0.76
Office (Regular Use)	1	0.85	0.75
Office (24Hours)	1	0.87	0.74
Schools and University	1	0.77	0.66
Open Gallery Mall	1	0.83	0.74
Shopping Mall	1	0.84	0.71
Supermarket	1	0.81	0.69
Strip retail	1	0.81	0.67

Table 9-8 Maximum Allowed EPI Ratios for Buildings in Warm and Humid Climate

Building Type	Warm and Humid		
	ECBC	ECBC+	SuperECBC
Hotel (No Star and Star)	1	0.91	0.81
Resort	1	0.88	0.75
Hospital	1	0.86	0.77
Outpatient	1	0.86	0.76
Assembly	1	0.88	0.80
Office (Regular Use)	1	0.86	0.76
Office (24Hours)	1	0.88	0.76
Schools and University	1	0.77	0.66
Open Gallery Mall	1	0.86	0.77
Shopping Mall	1	0.85	0.72
Supermarket	1	0.82	0.70
Strip retail	1	0.83	0.68

Table 9-9 Maximum Allowed EPI Ratios for Buildings in Cold Climate

Building Type	Cold		
	ECBC	ECBC+	SuperECBC
Hotel (No Star and Star)	1	0.91	0.82
Resort	1	0.88	0.75
Hospital	1	0.88	0.80
Outpatient	1	0.85	0.75
Assembly	1	0.87	0.81
Office (Regular Use)	1	0.88	0.80
Office (24Hours)	1	0.87	0.75
Schools and University	1	0.85	0.73
Open Gallery Mall	1	0.82	0.73
Shopping Mall	1	0.96	0.93
Supermarket	1	0.80	0.68
Strip retail	1	0.80	0.66

BEE Copy - Not For Circulation

9.6 Schedules

Table 9-10 Schedules for Business Buildings

Business								
Time Period	Occupancy Schedule		Lighting Schedule		Equipment Schedule		Elevator Schedule	
	Daytime Business	24 Hour Business	Daytime Business	24 Hour Business	Daytime Business	24 Hour Business	Daytime Business	24 Hour Business
00:00-01:00	0.00	0.90	0.05	0.90	0.00	0.95	0.05	0.55
01:00-02:00	0.00	0.90	0.05	0.90	0.00	0.95	0.05	0.25
02:00-03:00	0.00	0.90	0.05	0.90	0.00	0.95	0.05	0.25
03:00-04:00	0.00	0.90	0.05	0.90	0.00	0.95	0.05	0.15
04:00-05:00	0.00	0.50	0.05	0.50	0.00	0.00	0.05	0.35
05:00-06:00	0.00	0.20	0.05	0.05	0.00	0.00	0.05	0.50
06:00-07:00	0.00	0.10	0.10	0.05	0.00	0.00	0.20	0.20
07:00-08:00	0.10	0.10	0.30	0.90	0.00	0.95	0.40	0.40
08:00-09:00	0.20	0.90	0.90	0.90	0.10	0.95	0.80	0.80
09:00-10:00	0.95	0.90	0.90	0.90	0.90	0.95	0.80	0.80
10:00-11:00	0.95	0.90	0.90	0.90	0.90	0.95	0.55	0.55
11:00-12:00	0.95	0.90	0.90	0.90	0.90	0.95	0.35	0.35
12:00-13:00	0.95	0.90	0.90	0.90	0.90	0.95	0.25	0.25
13:00-14:00	0.50	0.20	0.50	0.50	0.80	0.20	0.95	0.95
14:00-15:00	0.95	0.90	0.90	0.90	0.90	0.95	0.95	0.95
15:00-16:00	0.95	0.90	0.90	0.90	0.90	0.95	0.35	0.35
16:00-17:00	0.95	0.90	0.90	0.90	0.90	0.95	0.15	0.35
17:00-18:00	0.95	0.90	0.95	0.90	0.90	0.95	0.75	0.70
18:00-19:00	0.30	0.90	0.50	0.90	0.50	0.20	0.95	0.95
19:00-20:00	0.10	0.20	0.30	0.90	0.10	0.95	0.50	0.50
20:00-21:00	0.10	0.90	0.30	0.90	0.10	0.95	0.30	0.35
21:00-22:00	0.10	0.90	0.20	0.90	0.00	0.95	0.20	0.25
22:00-23:00	0.00	0.90	0.10	0.90	0.00	0.95	0.05	0.25
23:00-24:00	0.00	0.90	0.05	0.90	0.00	0.20	0.05	0.55

Table 9-11 Schedules for Assembly Buildings

Assembly								
Time Period	Occupancy Schedule	Lighting Schedule	Equipment Schedule	Elevator Schedule	HVAC Fan Schedule (On/Off)	External Lighting Schedule	Basement Ventilation	Basement Lighting
00:00-01:00	0.00	0.00	0.00	0.00	0	0.80	0.00	0.80
01:00-02:00	0.00	0.00	0.00	0.00	0	0.80	0.00	0.10
02:00-03:00	0.00	0.00	0.00	0.00	0	0.80	0.00	0.10
03:00-04:00	0.00	0.00	0.00	0.00	0	0.80	0.00	0.10
04:00-05:00	0.00	0.00	0.00	0.00	0	0.80	0.00	0.10
05:00-06:00	0.00	0.00	0.00	0.00	0	0.80	0.00	0.10
06:00-07:00	0.00	0.00	0.00	0.00	0	0.00	0.00	0.10
07:00-08:00	0.00	0.00	0.00	0.00	0	0.00	0.00	0.10
08:00-09:00	0.20	0.40	0.30	0.20	0	0.00	1.00	0.80
09:00-10:00	0.20	0.75	0.50	0.50	1	0.00	1.00	0.80
10:00-11:00	0.20	0.95	0.95	0.50	1	0.00	1.00	0.80
11:00-12:00	0.80	0.95	0.95	0.50	1	0.00	1.00	0.80
12:00-13:00	0.80	0.95	0.95	0.50	1	0.00	1.00	0.80
13:00-14:00	0.80	0.95	0.95	0.50	1	0.00	1.00	0.80
14:00-15:00	0.80	0.95	0.95	0.50	1	0.00	1.00	0.80
15:00-16:00	0.80	0.95	0.95	0.50	1	0.00	1.00	0.80
16:00-17:00	0.80	0.95	0.95	0.50	1	0.00	1.00	0.80
17:00-18:00	0.80	0.95	0.95	0.50	1	0.00	1.00	0.80
18:00-19:00	0.50	0.95	0.50	0.50	1	0.80	1.00	0.80
19:00-20:00	0.20	0.40	0.30	0.40	1	0.80	1.00	0.80
20:00-21:00	0.20	0.40	0.30	0.20	0	0.80	1.00	0.80
21:00-22:00	0.20	0.40	0.30	0.20	0	0.80	1.00	0.80
22:00-23:00	0.10	0.10	0.00	0.00	0	0.80	1.00	0.80
23:00-24:00	0.10	0.10	0.00	0.00	0	0.80	0.00	0.80

Table 9-12 Schedules for Business - Office Buildings

Business - Office							
Time Period	HVAC Fan Schedule (On/Off)		External Lighting Schedule	Basement Ventilation		Basement Lighting	
	Daytime Business	24 Hours Business	7 Days/week	Daytime Business	24 Hours Business	Daytime Business	24 Hours Business
00:00-01:00	0	1	0.80	0.00	1.00	0.05	1.00
01:00-02:00	0	1	0.80	0.00	1.00	0.05	1.00
02:00-03:00	0	1	0.80	0.00	1.00	0.05	1.00
03:00-04:00	0	1	0.80	0.00	1.00	0.05	1.00
04:00-05:00	0	1	0.80	0.00	1.00	0.05	1.00
05:00-06:00	0	1	0.80	0.00	1.00	0.05	1.00
06:00-07:00	0	1	0.00	0.00	1.00	0.05	1.00
07:00-08:00	1	1	0.00	0.00	1.00	0.05	1.00
08:00-09:00	1	1	0.00	1.00	1.00	1.00	1.00
09:00-10:00	1	1	0.00	1.00	1.00	1.00	1.00
10:00-11:00	1	1	0.00	1.00	1.00	1.00	1.00
11:00-12:00	1	1	0.00	1.00	1.00	1.00	1.00
12:00-13:00	1	1	0.00	1.00	1.00	1.00	1.00
13:00-14:00	1	1	0.00	1.00	1.00	1.00	1.00
14:00-15:00	1	1	0.00	1.00	1.00	1.00	1.00
15:00-16:00	1	1	0.00	1.00	1.00	1.00	1.00
16:00-17:00	1	1	0.00	1.00	1.00	1.00	1.00
17:00-18:00	1	1	0.00	1.00	1.00	1.00	1.00
18:00-19:00	1	1	0.80	1.00	1.00	1.00	1.00
19:00-20:00	1	1	0.80	1.00	1.00	1.00	1.00
20:00-21:00	1	1	0.80	1.00	1.00	1.00	1.00
21:00-22:00	1	1	0.80	0.00	1.00	0.05	1.00
22:00-23:00	0	1	0.80	0.00	1.00	0.05	1.00
23:00-24:00	0	1	0.80	0.00	1.00	0.05	1.00

Table 9-13 Schedules for Educational - School Buildings (A)

Educational - School						
Time Period	Occupancy Schedule		Lighting Schedule		Equipment Schedule	
	Student Zone	Back Office	Student Zone	Back Office	Student Zone	Back Office
	5 Days/week	5 Days/week	5 Days/week	5 Days/week	5 Days/week	5 Days/week
00:00-01:00	0.00	0.00	0.00	0.00	0.00	0.00
01:00-02:00	0.00	0.00	0.00	0.00	0.00	0.00
02:00-03:00	0.00	0.00	0.00	0.00	0.00	0.00
03:00-04:00	0.00	0.00	0.00	0.00	0.00	0.00
04:00-05:00	0.00	0.00	0.00	0.00	0.00	0.00
05:00-06:00	0.00	0.00	0.00	0.00	0.00	0.00
06:00-07:00	0.00	0.00	0.00	0.20	0.00	0.00
07:00-08:00	0.70	0.00	0.90	0.70	0.35	0.35
08:00-09:00	0.90	0.90	0.90	0.90	0.95	0.95
09:00-10:00	0.90	0.90	0.90	0.90	0.95	0.95
10:00-11:00	0.90	0.90	0.90	0.90	0.95	0.95
11:00-12:00	0.20	0.90	0.20	0.90	0.20	0.95
12:00-13:00	0.90	0.90	0.90	0.90	0.95	0.95
13:00-14:00	0.90	0.20	0.90	0.30	0.95	0.40
14:00-15:00	0.00	0.90	0.00	0.90	0.00	0.95
15:00-16:00	0.00	0.90	0.00	0.90	0.00	0.95
16:00-17:00	0.00	0.90	0.00	0.90	0.00	0.95
17:00-18:00	0.00	0.50	0.00	0.30	0.00	0.25
18:00-19:00	0.00	0.00	0.00	0.10	0.00	0.00
19:00-20:00	0.00	0.00	0.00	0.00	0.00	0.00
20:00-21:00	0.00	0.00	0.00	0.00	0.00	0.00
21:00-22:00	0.00	0.00	0.00	0.00	0.00	0.00
22:00-23:00	0.00	0.00	0.00	0.00	0.00	0.00
23:00-24:00	0.00	0.00	0.00	0.00	0.00	0.00

Schedules for Educational - School Buildings (B)

Educational - School						
Time Period	Elevator Schedule	HVAC Fan Schedule (On/Off)		External Lighting Schedule	Basement Ventilation	Basement Lighting
		Student Area	Back Office			
	7 Days/week	5 Days/week	5 Days/week	7 Days/week	7 Days/week	7 Days/week
00:00-01:00	0.00	0	0	0.80	0.00	0.05
01:00-02:00	0.00	0	0	0.80	0.00	0.05
02:00-03:00	0.00	0	0	0.80	0.00	0.05
03:00-04:00	0.00	0	0	0.80	0.00	0.05
04:00-05:00	0.00	0	0	0.80	0.00	0.05
05:00-06:00	0.00	0	0	0.80	0.00	0.05
06:00-07:00	0.05	0	0	0.00	0.00	0.05
07:00-08:00	0.80	1	1	0.00	0.00	0.05
08:00-09:00	0.80	1	1	0.00	1.00	1.00
09:00-10:00	0.25	1	1	0.00	1.00	1.00
10:00-11:00	0.25	1	1	0.00	1.00	1.00
11:00-12:00	0.25	1	1	0.00	1.00	1.00
12:00-13:00	0.25	1	1	0.00	1.00	1.00
13:00-14:00	0.90	1	1	0.00	1.00	1.00
14:00-15:00	0.60	0	1	0.00	1.00	1.00
15:00-16:00	0.20	0	1	0.00	1.00	1.00
16:00-17:00	0.30	0	1	0.00	1.00	1.00
17:00-18:00	0.40	0	0	0.00	1.00	0.50
18:00-19:00	0.00	0	0	0.80	0.00	0.05
19:00-20:00	0.00	0	0	0.80	0.00	0.05
20:00-21:00	0.00	0	0	0.80	0.00	0.05
21:00-22:00	0.00	0	0	0.80	0.00	0.05
22:00-23:00	0.00	0	0	0.80	0.00	0.05
23:00-24:00	0.00	0	0	0.80	0.00	0.05

Table 9-14 Schedules for Educational - University Buildings (A)

Educational - University									
Time Period	Occupancy Schedule			Lighting Schedule			Equipment Schedule		
	Student Zone	Back Office	Library & Computer Centre	Student Zone	Back Office	Library & Computer Centre	Student Zone	Back Office	Library & Computer Centre
	5 Days/ week	5 Days/ week	7 Days/ week	5 Days/ week	5 Days/ week	7 Days/ week	5 Days/ week	5 Days/ week	7 Days/ week
00:00-01:00	0.00	0.00	0.00	0.00	0.00	0.00	0.00	0.10	0.10
01:00-02:00	0.00	0.00	0.00	0.00	0.00	0.00	0.00	0.10	0.10
02:00-03:00	0.00	0.00	0.00	0.00	0.00	0.00	0.00	0.10	0.10
03:00-04:00	0.00	0.00	0.00	0.00	0.00	0.00	0.00	0.10	0.10
04:00-05:00	0.00	0.00	0.00	0.00	0.00	0.00	0.00	0.10	0.10
05:00-06:00	0.00	0.00	0.00	0.00	0.00	0.00	0.00	0.10	0.10
06:00-07:00	0.00	0.00	0.00	0.00	0.00	0.00	0.00	0.10	0.10
07:00-08:00	0.40	0.00	0.00	0.90	0.00	0.00	0.35	0.35	0.10
08:00-09:00	0.90	0.90	0.30	0.90	0.90	0.90	0.95	0.95	0.70
09:00-10:00	0.90	0.90	0.40	0.90	0.90	0.90	0.95	0.95	0.70
10:00-11:00	0.90	0.90	0.50	0.90	0.90	0.90	0.95	0.95	0.70
11:00-12:00	0.90	0.90	0.50	0.90	0.90	0.90	0.95	0.95	0.70
12:00-13:00	0.90	0.90	0.50	0.90	0.90	0.90	0.95	0.95	0.70
13:00-14:00	0.10	0.20	0.20	0.60	0.30	0.20	0.20	0.40	0.70
14:00-15:00	0.90	0.90	0.50	0.90	0.90	0.90	0.95	0.95	0.70
15:00-16:00	0.90	0.90	0.50	0.90	0.90	0.90	0.95	0.95	0.70
16:00-17:00	0.90	0.90	0.50	0.90	0.90	0.90	0.95	0.95	0.70
17:00-18:00	0.40	0.00	0.50	0.90	0.50	0.90	0.95	0.10	0.80
18:00-19:00	0.00	0.00	0.60	0.00	0.00	0.90	0.00	0.10	0.80
19:00-20:00	0.00	0.00	0.60	0.00	0.00	0.90	0.00	0.10	0.80
20:00-21:00	0.00	0.00	0.60	0.00	0.00	0.90	0.00	0.10	0.80
21:00-22:00	0.00	0.00	0.60	0.00	0.00	0.90	0.00	0.10	0.80
22:00-23:00	0.00	0.00	0.60	0.00	0.00	0.90	0.00	0.10	0.80
23:00-24:00	0.00	0.00	0.00	0.00	0.00	0.00	0.00	0.10	0.00

Schedules for Educational - University Buildings (B)

University								
Time Period	Elevator Schedule		HVAC Fan Schedule (On/Off)			External Lighting Schedule	Basement Ventilation	Basement Lighting
	Library & Comp. Centre	Student and Back office	Student Area	Back Office	Library & Comp. Centre			
	7 days/ week	7 days/ week	5 days/ week	5 days/ week	7 days/ week			
00:00-01:00	0.00	0.00	0	0	0	0.80	0.00	0.05
01:00-02:00	0.00	0.00	0	0	0	0.80	0.00	0.05
02:00-03:00	0.00	0.00	0	0	0	0.80	0.00	0.05
03:00-04:00	0.00	0.00	0	0	0	0.80	0.00	0.05
04:00-05:00	0.00	0.00	0	0	0	0.80	0.00	0.05
05:00-06:00	0.00	0.00	0	0	0	0.80	0.00	0.05
06:00-07:00	0.00	0.05	0	0	0	0.00	0.00	0.05
07:00-08:00	0.00	0.25	1	1	1	0.00	0.00	0.05
08:00-09:00	0.50	0.85	1	1	1	0.00	1.00	1.00
09:00-10:00	0.50	0.25	1	1	1	0.00	1.00	1.00
10:00-11:00	0.30	0.25	1	1	1	0.00	1.00	1.00
11:00-12:00	0.20	0.25	1	1	1	0.00	1.00	1.00
12:00-13:00	0.20	0.25	1	1	1	0.00	1.00	1.00
13:00-14:00	0.40	0.90	1	1	1	0.00	1.00	1.00
14:00-15:00	0.30	0.60	1	1	1	0.00	1.00	1.00
15:00-16:00	0.30	0.25	1	1	1	0.00	1.00	1.00
16:00-17:00	0.30	0.25	1	1	1	0.00	1.00	1.00
17:00-18:00	0.50	0.90	1	0	1	0.00	1.00	1.00
18:00-19:00	0.50	0.15	0	0	1	0.80	1.00	1.00
19:00-20:00	0.50	0.05	0	0	1	0.80	1.00	1.00
20:00-21:00	0.50	0.00	0	0	1	0.80	0.00	0.50
21:00-22:00	0.50	0.00	0	0	1	0.80	0.00	0.05
22:00-23:00	0.50	0.00	0	0	1	0.80	0.00	0.05
23:00-24:00	0.00	0.00	0	0	0	0.80	0.00	0.05

Table 9-15 Schedules for Healthcare - Hospital Buildings (A)

Healthcare - Hospital								
Time Period	Occupancy Schedule				Lighting Schedule			
	In Patient & ICU	Public Spaces	OPD & Offices	Diagnostic, emergency & OT	Public Spaces	In Patient & ICU	Diagnostic, emergency, & OT	OPD & Offices
	7 days/week	7 days/week	6 days/week	7 days/week	7 days/week	7 days/week	7 days/week	6 days/week
00:00-01:00	0.90	0.00	0.00	0.50	0.10	0.10	0.50	0.05
01:00-02:00	0.90	0.00	0.00	0.40	0.10	0.10	0.50	0.05
02:00-03:00	0.90	0.00	0.00	0.40	0.10	0.10	0.50	0.05
03:00-04:00	0.90	0.00	0.00	0.40	0.10	0.10	0.50	0.05
04:00-05:00	0.90	0.00	0.00	0.40	0.10	0.10	0.50	0.05
05:00-06:00	0.90	0.00	0.00	0.40	0.10	0.10	0.50	0.05
06:00-07:00	0.90	0.00	0.00	0.50	0.10	0.10	0.50	0.10
07:00-08:00	0.90	0.10	0.10	0.70	0.50	0.20	0.50	0.30
08:00-09:00	0.90	0.50	0.30	0.70	0.90	0.20	0.90	0.90
09:00-10:00	0.90	0.95	0.90	0.95	0.90	0.20	0.90	0.90
10:00-11:00	0.90	0.95	0.90	0.95	0.90	0.20	0.90	0.90
11:00-12:00	0.90	0.95	0.50	0.95	0.90	0.20	0.90	0.90
12:00-13:00	0.90	0.95	0.20	0.95	0.90	0.20	0.90	0.90
13:00-14:00	0.90	0.95	0.50	0.95	0.90	0.20	0.90	0.50
14:00-15:00	0.90	0.95	0.90	0.95	0.90	0.20	0.90	0.90
15:00-16:00	0.90	0.95	0.90	0.95	0.90	0.20	0.90	0.90
16:00-17:00	0.90	0.95	0.90	0.95	0.30	0.20	0.90	0.90
17:00-18:00	0.90	0.70	0.90	0.95	0.30	0.70	0.90	0.90
18:00-19:00	0.90	0.50	0.50	0.95	0.30	0.90	0.90	0.50
19:00-20:00	0.90	0.30	0.50	0.95	0.30	0.90	0.90	0.50
20:00-21:00	0.90	0.10	0.50	0.70	0.30	0.90	0.50	0.30
21:00-22:00	0.90	0.00	0.10	0.70	0.30	0.90	0.50	0.20
22:00-23:00	0.90	0.00	0.00	0.50	0.30	0.70	0.50	0.10
23:00-24:00	0.90	0.00	0.00	0.50	0.10	0.10	0.50	0.05

Schedules for Healthcare - Hospital Buildings (B)

Healthcare - Hospital							
Time Period	Equipment Schedule					Elevator Schedule	
	In Patient & ICU	Diagnostic, emergency, & OT	OPD & Offices			Elevator	
	7 days/ week	7 days/ week	7 days/ week			7 days/ week	
00-01 Hrs	0.40	0.00	0.00			0.20	
01-02 Hrs	0.40	0.00	0.00			0.20	
02-03 Hrs	0.40	0.00	0.00			0.20	
03-04 Hrs	0.40	0.00	0.00			0.20	
04-05 Hrs	0.40	0.00	0.00			0.20	
05-06 Hrs	0.40	0.00	0.00			0.20	
06-07 Hrs	0.40	0.00	0.00			0.20	
07-08 Hrs	0.70	0.70	0.70			0.50	
08-09 Hrs	0.90	0.90	0.90			0.75	
09-10 Hrs	0.90	0.90	0.90			1.00	
10-11 Hrs	0.90	0.90	0.90			1.00	
11-12 Hrs	0.90	0.90	0.90			1.00	
12-13 Hrs	0.90	0.90	0.90			0.75	
13-14 Hrs	0.90	0.90	0.90			1.00	
14-15 Hrs	0.90	0.90	0.90			1.00	
15-16 Hrs	0.90	0.90	0.90			1.00	
16-17 Hrs	0.60	0.60	0.90			1.00	
17-18 Hrs	0.60	0.60	0.90			1.00	
18-19 Hrs	0.60	0.60	0.60			0.50	
19-20 Hrs	0.60	0.60	0.60			0.50	
20-21 Hrs	0.60	0.60	0.60			0.50	
21-22 Hrs	0.60	0.00	0.00			0.30	
22-23 Hrs	0.60	0.00	0.00			0.20	
23-00 Hrs	0.40	0.00	0.00			0.20	

Schedules for Healthcare - Hospital Buildings (C)

Healthcare - Hospital									
Time Period	HVAC Fan Schedule (On/Off)				External Lighting Schedule	Service Hot Water		Basement Ventilation	Basement Lighting
	Public Spaces	Beds & ICU	Diagn, emerg, & OT	OPD & Offices		Building Summer	Building Winters		
	7 days/ week	7 days/ week	7 days/ week	7 days/ week		7 days/ week	7 days/ week		
00:00-01:00	0	1	1	0	1.00	0.00	0.30	0.50	0.50
01:00-02:00	0	1	1	0	1.00	0.00	0.30	0.50	0.50
02:00-03:00	0	1	1	0	1.00	0.00	0.30	0.50	0.50
03:00-04:00	0	1	1	0	1.00	0.00	0.30	0.50	0.50
04:00-05:00	0	1	1	0	1.00	0.00	0.30	0.50	0.50
05:00-06:00	0	1	1	0	1.00	0.00	0.30	0.50	0.50
06:00-07:00	0	1	1	0	0.00	0.00	0.30	0.50	0.50
07:00-08:00	1	1	1	0	0.00	0.00	0.20	0.50	0.50
08:00-09:00	1	1	1	1	0.00	0.20	0.60	1.00	1.00
09:00-10:00	1	1	1	1	0.00	0.30	0.60	1.00	1.00
10:00-11:00	1	1	1	1	0.00	0.30	0.80	1.00	1.00
11:00-12:00	1	1	1	1	0.00	0.30	0.80	1.00	1.00
12:00-13:00	1	1	1	1	0.00	0.25	0.70	1.00	1.00
13:00-14:00	1	1	1	1	0.00	0.25	0.80	1.00	1.00
14:00-15:00	1	1	1	1	0.00	0.25	0.80	1.00	1.00
15:00-16:00	1	1	1	1	0.00	0.25	0.70	1.00	1.00
16:00-17:00	1	1	1	1	0.00	0.25	0.70	1.00	1.00
17:00-18:00	1	1	1	1	0.00	0.10	0.50	1.00	1.00
18:00-19:00	1	1	1	1	1.00	0.00	0.35	1.00	1.00
19:00-20:00	1	1	1	1	1.00	0.00	0.35	1.00	1.00
20:00-21:00	1	1	1	1	1.00	0.00	0.35	1.00	1.00
21:00-22:00	1	1	1	0	1.00	0.00	0.30	0.50	0.50
22:00-23:00	0	1	1	0	1.00	0.00	0.30	0.50	0.50
23:00-24:00	0	1	1	0	1.00	0.00	0.30	0.50	0.50

Table 9-16 Schedules for Healthcare – Out-patient Healthcare Buildings (A)

Healthcare – Out-patient Healthcare							
Time Period	Occupancy Schedule			Lighting Schedule		Equipment Schedule	
	Lobby	Diagnostic & Emergency	OPD & Back Office	Diagnostic & Emergency	OPD & Back Office	Diagnostic & Emergency	OPD & Back Office
	6 days/ week	6 days/ week	6 days/ week	6 days/ week	6 days/ week	6 days/ week	6 days/ week
00:00-01:00	0.00	0.00	0.00	0.10	0.00	0.00	0.00
01:00-02:00	0.00	0.00	0.00	0.10	0.00	0.00	0.00
02:00-03:00	0.00	0.00	0.00	0.10	0.00	0.00	0.00
03:00-04:00	0.00	0.00	0.00	0.10	0.00	0.00	0.00
04:00-05:00	0.00	0.00	0.00	0.10	0.00	0.00	0.00
05:00-06:00	0.00	0.00	0.00	0.10	0.00	0.00	0.00
06:00-07:00	0.00	0.20	0.20	0.10	0.10	0.00	0.00
07:00-08:00	0.10	0.20	0.20	0.50	0.30	0.50	0.00
08:00-09:00	0.50	0.30	0.20	0.90	0.90	0.95	0.95
09:00-10:00	0.80	0.90	0.90	0.90	0.90	0.95	0.95
10:00-11:00	0.80	0.90	0.90	0.90	0.90	0.95	0.95
11:00-12:00	0.80	0.90	0.90	0.90	0.90	0.95	0.95
12:00-13:00	0.80	0.90	0.50	0.90	0.90	0.95	0.95
13:00-14:00	0.80	0.90	0.20	0.90	0.50	0.95	0.95
14:00-15:00	0.80	0.90	0.50	0.90	0.90	0.95	0.95
15:00-16:00	0.80	0.90	0.90	0.90	0.90	0.95	0.95
16:00-17:00	0.80	0.90	0.90	0.90	0.90	0.95	0.95
17:00-18:00	0.80	0.90	0.90	0.90	0.95	0.95	0.95
18:00-19:00	0.80	0.90	0.50	0.90	0.95	0.95	0.95
19:00-20:00	0.80	0.90	0.50	0.90	0.30	0.95	0.95
20:00-21:00	0.20	0.65	0.20	0.90	0.30	0.80	0.80
21:00-22:00	0.20	0.20	0.20	0.50	0.20	0.00	0.00
22:00-23:00	0.00	0.00	0.00	0.30	0.00	0.00	0.00
23:00-24:00	0.00	0.00	0.00	0.10	0.00	0.00	0.00

Schedules for Healthcare – Out-patient Healthcare Buildings (B)

Healthcare - Out-patient Healthcare							
Time Period	Elevator Schedule	HVAC Fan Schedule (On/Off)	External Lighting Schedule	Service Hot Water (SHW)		Basement Ventilation	Basement Lighting
		All Spaces		Building Summer	Building Winters		
	6 days/ week	6 days/ week	7 Days/ week	6 days/ week	6 days/ week	6 days/ week	6 days/ week
00:00-01:00	0.05	0	0.20	0.00	0.00	0.00	0.00
01:00-02:00	0.05	0	0.20	0.00	0.00	0.00	0.00
02:00-03:00	0.05	0	0.20	0.00	0.00	0.00	0.00
03:00-04:00	0.05	0	0.20	0.00	0.00	0.00	0.00
04:00-05:00	0.05	0	0.20	0.00	0.00	0.00	0.00
05:00-06:00	0.05	0	0.20	0.00	0.00	0.00	0.00
06:00-07:00	0.05	0	0.00	0.00	0.00	0.00	0.00
07:00-08:00	0.50	0	0.00	0.00	0.20	0.00	0.00
08:00-09:00	0.75	1	0.00	0.20	0.60	1.00	1.00
09:00-10:00	1.00	1	0.00	0.30	0.60	1.00	1.00
10:00-11:00	1.00	1	0.00	0.30	0.80	1.00	1.00
11:00-12:00	1.00	1	0.00	0.30	0.80	1.00	1.00
12:00-13:00	0.75	1	0.00	0.25	0.70	1.00	1.00
13:00-14:00	1.00	1	0.00	0.25	0.80	1.00	1.00
14:00-15:00	1.00	1	0.00	0.25	0.80	1.00	1.00
15:00-16:00	1.00	1	0.00	0.25	0.70	1.00	1.00
16:00-17:00	1.00	1	0.00	0.25	0.70	1.00	1.00
17:00-18:00	1.00	1	0.00	0.10	0.50	1.00	1.00
18:00-19:00	0.50	1	0.50	0.01	0.20	1.00	1.00
19:00-20:00	0.50	1	0.50	0.01	0.20	1.00	1.00
20:00-21:00	0.50	1	0.50	0.01	0.20	1.00	1.00
21:00-22:00	0.30	0	0.50	0.01	0.10	1.00	1.00
22:00-23:00	0.05	0	0.20	0.01	0.01	0.00	0.00
23:00-24:00	0.05	0	0.20	0.01	0.01	0.00	0.00

Table 9-17 Schedules for Hospitality Buildings (A)

Hospitality								
Time Period	Occupancy Schedule							
	Guest Room		Lobby		Special Zones		Restaurant	
	Week Days	Weekends	Week Days	Weekends	Week Days	Weekends	Week Days	Weekends
00:00-01:00	0.65	0.90	0.10	0.10	0.00	0.00	0.00	0.00
01:00-02:00	0.65	0.90	0.10	0.10	0.00	0.00	0.00	0.00
02:00-03:00	0.65	0.90	0.10	0.10	0.00	0.00	0.00	0.00
03:00-04:00	0.65	0.90	0.10	0.10	0.00	0.00	0.00	0.00
04:00-05:00	0.65	0.90	0.10	0.10	0.00	0.00	0.00	0.00
05:00-06:00	0.65	0.90	0.10	0.10	0.20	0.50	0.00	0.00
06:00-07:00	0.50	0.70	0.20	0.20	0.40	0.70	0.30	0.50
07:00-08:00	0.50	0.70	0.30	0.40	0.40	0.70	0.50	0.80
08:00-09:00	0.30	0.50	0.40	0.70	0.40	0.70	0.50	0.80
09:00-10:00	0.15	0.30	0.40	0.70	0.40	0.70	0.50	0.80
10:00-11:00	0.15	0.20	0.40	0.70	0.40	0.70	0.50	0.80
11:00-12:00	0.15	0.20	0.40	0.70	0.20	0.30	0.00	0.00
12:00-13:00	0.15	0.20	0.40	0.70	0.20	0.30	0.00	0.00
13:00-14:00	0.15	0.20	0.20	0.20	0.20	0.30	0.50	0.50
14:00-15:00	0.15	0.20	0.20	0.20	0.20	0.30	0.50	0.80
15:00-16:00	0.15	0.20	0.20	0.20	0.40	0.70	0.00	0.80
16:00-17:00	0.15	0.20	0.20	0.20	0.40	0.70	0.30	0.30
17:00-18:00	0.30	0.30	0.40	0.40	0.40	0.70	0.30	0.30
18:00-19:00	0.50	0.50	0.40	0.40	0.40	0.70	0.00	0.00
19:00-20:00	0.50	0.70	0.40	0.40	0.40	0.70	0.30	0.50
20:00-21:00	0.65	0.70	0.30	0.30	0.00	0.00	0.50	0.90
21:00-22:00	0.65	0.90	0.20	0.20	0.00	0.00	0.50	0.90
22:00-23:00	0.65	0.90	0.10	0.10	0.00	0.00	0.50	0.90
23:00-24:00	0.65	0.90	0.10	0.10	0.00	0.00	0.50	0.90

Schedules for Hospitality Buildings (B)

Hospitality								
Time Period	Occupancy Schedule				Lighting Schedule			
	Back office		Conference / Banquet Rooms	Kitchen	Public Spaces		Guest Rooms	
	Week Days	Weekends	7 Days/ week	7 Days/ week	Week Days	Weekends	Week Days	Weekends
00:00-01:00	0.20	0.20	0.00	0.00	0.20	0.20	0.20	0.30
01:00-02:00	0.20	0.20	0.00	0.00	0.15	0.20	0.20	0.25
02:00-03:00	0.20	0.20	0.00	0.00	0.10	0.10	0.10	0.10
03:00-04:00	0.20	0.20	0.00	0.00	0.10	0.10	0.10	0.10
04:00-05:00	0.20	0.20	0.00	0.00	0.10	0.10	0.10	0.10
05:00-06:00	0.20	0.20	0.00	0.00	0.20	0.10	0.20	0.10
06:00-07:00	0.20	0.20	0.00	0.50	0.40	0.30	0.45	0.40
07:00-08:00	0.20	0.20	0.00	0.80	0.50	0.30	0.55	0.40
08:00-09:00	0.20	0.20	0.20	0.80	0.40	0.40	0.45	0.55
09:00-10:00	0.95	0.50	0.50	0.50	0.20	0.40	0.20	0.20
10:00-11:00	0.95	0.50	0.90	0.50	0.20	0.40	0.20	0.20
11:00-12:00	0.95	0.50	0.90	0.80	0.20	0.40	0.20	0.20
12:00-13:00	0.95	0.50	0.90	0.80	0.20	0.40	0.20	0.20
13:00-14:00	0.50	0.30	0.90	0.80	0.20	0.40	0.20	0.20
14:00-15:00	0.95	0.50	0.90	0.50	0.20	0.40	0.20	0.20
15:00-16:00	0.95	0.50	0.90	0.50	0.20	0.40	0.20	0.20
16:00-17:00	0.95	0.50	0.90	0.50	0.20	0.40	0.20	0.20
17:00-18:00	0.95	0.50	0.50	0.80	0.25	0.40	0.30	0.30
18:00-19:00	0.30	0.30	0.20	0.80	0.60	0.60	0.70	0.85
19:00-20:00	0.20	0.20	0.20	0.80	0.80	0.70	0.90	1.00
20:00-21:00	0.20	0.20	0.00	0.80	0.90	0.70	1.00	1.00
21:00-22:00	0.20	0.20	0.00	0.80	0.80	0.70	0.90	1.00
22:00-23:00	0.20	0.20	0.00	0.50	0.60	0.60	0.70	0.85
23:00-24:00	0.20	0.20	0.00	0.50	0.30	0.30	0.30	0.40

Schedules for Hospitality Buildings (C)

Hospitality									
Time Period	Lighting Schedule			Equipment Schedule					
	Back Office		Kitchen	Public Spaces	Guest Rooms		Back Office		Kitchen
	Week Days	Weekends			7 Days/ week	7 Days/ week	Week Days	Weekends	
00:00-01:00	0.05	0.05	0.50	0.30	0.20	0.20	0.05	0.05	0.30
01:00-02:00	0.05	0.05	0.05	0.20	0.20	0.20	0.05	0.05	0.10
02:00-03:00	0.05	0.05	0.05	0.20	0.20	0.20	0.05	0.05	0.10
03:00-04:00	0.05	0.05	0.05	0.20	0.20	0.20	0.05	0.05	0.10
04:00-05:00	0.05	0.05	0.05	0.20	0.20	0.20	0.05	0.05	0.10
05:00-06:00	0.05	0.05	0.05	0.30	0.20	0.20	0.05	0.05	0.10
06:00-07:00	0.10	0.10	0.10	0.50	0.30	0.30	0.05	0.05	0.30
07:00-08:00	0.30	0.30	0.30	0.50	0.40	0.60	0.10	0.10	0.30
08:00-09:00	0.90	0.60	0.90	0.50	0.70	0.90	0.30	0.30	0.30
09:00-10:00	0.90	0.60	0.90	0.50	0.20	0.20	0.95	0.70	0.30
10:00-11:00	0.90	0.60	0.90	0.35	0.20	0.20	0.95	0.70	0.30
11:00-12:00	0.90	0.60	0.90	0.35	0.20	0.20	0.95	0.70	0.30
12:00-13:00	0.90	0.60	0.90	0.35	0.20	0.20	0.95	0.70	0.30
13:00-14:00	0.50	0.50	0.50	0.35	0.20	0.20	0.50	0.70	0.30
14:00-15:00	0.90	0.60	0.90	0.35	0.20	0.20	0.95	0.70	0.30
15:00-16:00	0.90	0.60	0.90	0.35	0.20	0.20	0.95	0.70	0.30
16:00-17:00	0.90	0.60	0.90	0.35	0.20	0.20	0.95	0.70	0.30
17:00-18:00	0.95	0.60	0.95	0.35	0.30	0.30	0.95	0.70	0.30
18:00-19:00	0.50	0.50	0.95	0.70	0.50	0.50	0.30	0.30	0.30
19:00-20:00	0.30	0.30	0.95	0.90	0.50	0.50	0.10	0.10	0.30
20:00-21:00	0.30	0.30	0.95	0.90	0.50	0.70	0.10	0.10	0.30
21:00-22:00	0.20	0.20	0.95	0.90	0.70	0.70	0.10	0.10	0.30
22:00-23:00	0.10	0.10	0.95	0.70	0.40	0.40	0.05	0.05	0.30
23:00-24:00	0.05	0.05	0.95	0.40	0.20	0.20	0.05	0.05	0.30

Schedules for Hospitality Buildings (D)

Hospitality						
Time Period	Elevator Schedule		HVAC Fan Schedule (On/Off)			
			Public Spaces	Guest Room		Back office
	Week Days	Weekends	7 Days/ week	Week Days	Weekends	7 Days/ week
00:00-01:00	0.10	0.10	0	1	1	0
01:00-02:00	0.10	0.10	0	1	1	0
02:00-03:00	0.10	0.10	0	1	1	0
03:00-04:00	0.10	0.10	0	1	1	0
04:00-05:00	0.10	0.10	0	1	1	0
05:00-06:00	0.20	0.20	0	1	1	0
06:00-07:00	0.40	0.50	0	1	1	0
07:00-08:00	0.50	0.60	1	1	1	0
08:00-09:00	0.50	0.60	1	1	1	1
09:00-10:00	0.35	0.40	1	1	1	1
10:00-11:00	0.15	0.20	1	1	1	1
11:00-12:00	0.15	0.20	1	1	1	1
12:00-13:00	0.15	0.20	1	1	1	1
13:00-14:00	0.15	0.20	1	1	1	1
14:00-15:00	0.15	0.20	1	1	1	1
15:00-16:00	0.15	0.20	1	1	1	1
16:00-17:00	0.35	0.40	1	1	1	1
17:00-18:00	0.50	0.60	1	1	1	1
18:00-19:00	0.50	0.60	1	1	1	1
19:00-20:00	0.50	0.60	1	1	1	0
20:00-21:00	0.50	0.60	1	1	1	0
21:00-22:00	0.30	0.40	1	1	1	0
22:00-23:00	0.20	0.30	1	1	1	0
23:00-24:00	0.10	0.10	1	1	1	0

Schedules for Hospitality Buildings (E)

Hospitality						
Time Period	External Lighting Schedule	Service Hot Water (SHW)			Basement Ventilation	Basement Lighting
		Guest rooms		Laundry		
	7 Days/ week	Week Days	Weekends	7 Days/ week	7 Days/ week	7 Days/ week
00:00-01:00	1.00	0.01	0.01	0.00	0.50	0.50
01:00-02:00	1.00	0.01	0.01	0.00	0.50	0.50
02:00-03:00	1.00	0.01	0.01	0.00	0.50	0.50
03:00-04:00	1.00	0.01	0.01	0.00	0.50	0.50
04:00-05:00	1.00	0.01	0.01	0.00	0.50	0.50
05:00-06:00	1.00	0.01	0.01	0.00	0.50	0.50
06:00-07:00	0.00	0.50	0.70	0.00	0.50	0.50
07:00-08:00	0.00	0.50	0.70	0.00	0.50	0.50
08:00-09:00	0.00	0.30	0.50	1.00	1.00	1.00
09:00-10:00	0.00	0.15	0.30	1.00	1.00	1.00
10:00-11:00	0.00	0.15	0.20	1.00	1.00	1.00
11:00-12:00	0.00	0.15	0.20	1.00	1.00	1.00
12:00-13:00	0.00	0.15	0.20	1.00	1.00	1.00
13:00-14:00	0.00	0.15	0.20	1.00	1.00	1.00
14:00-15:00	0.00	0.15	0.20	1.00	1.00	1.00
15:00-16:00	0.00	0.15	0.20	1.00	1.00	1.00
16:00-17:00	0.00	0.15	0.20	0.00	1.00	1.00
17:00-18:00	0.00	0.30	0.30	0.00	1.00	1.00
18:00-19:00	1.00	0.50	0.50	0.00	1.00	1.00
19:00-20:00	1.00	0.50	0.70	0.00	1.00	1.00
20:00-21:00	1.00	0.65	0.70	0.00	1.00	1.00
21:00-22:00	1.00	0.65	0.90	0.00	0.50	0.50
22:00-23:00	1.00	0.01	0.01	0.00	0.50	0.50
23:00-24:00	1.00	0.01	0.01	0.00	0.50	0.50

Table 9-18 Schedules for Shopping Complexes Buildings (A)

Shopping Complex									
Time Period	Occupancy Schedule						Lighting Schedule		
	Retail		Corridors & Atrium		Special Zone		Retail	Corridors & Atrium	Special Zone
	Week day	Week end	Week day	Week end	Week day	Week end	7 Days/ week	7 Days/ week	7 Days/ week
00:00-01:00	0.00	0.00	0.00	0.10	0.00	0.00	0.05	0.05	0.05
01:00-02:00	0.00	0.00	0.00	0.00	0.00	0.00	0.05	0.05	0.05
02:00-03:00	0.00	0.00	0.00	0.00	0.00	0.00	0.05	0.05	0.05
03:00-04:00	0.00	0.00	0.00	0.00	0.00	0.00	0.05	0.05	0.05
04:00-05:00	0.00	0.00	0.00	0.00	0.00	0.00	0.05	0.05	0.05
05:00-06:00	0.00	0.00	0.00	0.00	0.00	0.00	0.05	0.05	0.05
06:00-07:00	0.00	0.00	0.00	0.00	0.00	0.00	0.05	0.05	0.05
07:00-08:00	0.00	0.00	0.00	0.00	0.00	0.00	0.05	0.05	0.05
08:00-09:00	0.00	0.00	0.00	0.00	0.00	0.00	0.05	0.05	0.05
09:00-10:00	0.20	0.20	0.20	0.20	0.20	0.20	0.20	0.20	0.20
10:00-11:00	0.40	0.40	0.40	0.40	0.20	0.20	0.50	0.50	0.40
11:00-12:00	0.60	0.60	0.60	0.60	0.30	0.50	0.95	0.50	0.60
12:00-13:00	0.60	0.70	0.60	0.70	0.50	0.70	0.95	0.50	0.60
13:00-14:00	0.60	0.90	0.60	0.90	0.50	0.70	0.95	0.50	0.60
14:00-15:00	0.70	0.90	0.70	0.90	0.50	0.70	0.95	0.50	0.60
15:00-16:00	0.70	0.90	0.70	0.90	0.50	0.80	0.95	0.50	0.40
16:00-17:00	0.70	0.90	0.70	0.90	0.50	0.80	0.95	0.70	0.40
17:00-18:00	0.70	0.90	0.70	0.90	0.50	0.80	0.95	0.95	0.40
18:00-19:00	0.90	0.95	0.90	0.95	0.60	0.95	0.95	0.95	0.80
19:00-20:00	0.90	0.95	0.90	0.95	0.60	0.95	0.95	0.95	0.80
20:00-21:00	0.90	0.95	0.90	0.95	0.60	0.95	0.95	0.95	0.80
21:00-22:00	0.00	0.00	0.40	0.40	0.60	0.95	0.05	0.50	0.80
22:00-23:00	0.00	0.00	0.30	0.30	0.60	0.95	0.05	0.30	0.80
23:00-24:00	0.00	0.00	0.10	0.10	0.30	0.95	0.05	0.30	0.80

Schedules for Shopping Complexes Buildings (B)

Shopping Complex				
Time Period	Equipment Schedule		Elevator Schedule	
	Retail	Special Zone		
	7 Days/ week	7 Days/ week	Weekdays	Weekends
00:00-01:00	0.05	0.05	0.20	0.20
01:00-02:00	0.05	0.05	0.05	0.20
02:00-03:00	0.05	0.05	0.05	0.05
03:00-04:00	0.05	0.05	0.05	0.05
04:00-05:00	0.05	0.05	0.05	0.05
05:00-06:00	0.05	0.05	0.05	0.05
06:00-07:00	0.05	0.05	0.05	0.05
07:00-08:00	0.05	0.05	0.10	0.10
08:00-09:00	0.05	0.50	0.10	0.10
09:00-10:00	0.05	0.50	0.20	0.20
10:00-11:00	0.90	0.90	0.40	0.40
11:00-12:00	0.90	0.90	0.70	0.70
12:00-13:00	0.90	0.90	0.70	0.80
13:00-14:00	0.90	0.90	0.70	0.95
14:00-15:00	0.90	0.90	0.70	0.95
15:00-16:00	0.90	0.90	0.70	0.95
16:00-17:00	0.90	0.90	0.70	0.95
17:00-18:00	0.90	0.90	0.80	0.95
18:00-19:00	0.90	0.90	0.80	0.95
19:00-20:00	0.90	0.90	0.80	0.95
20:00-21:00	0.50	0.90	0.80	0.95
21:00-22:00	0.05	0.90	0.80	0.80
22:00-23:00	0.05	0.90	0.50	0.60
23:00-24:00	0.05	0.90	0.30	0.40

Schedules for Shopping Complexes Buildings (C)

Shopping Complex						
Time Period	HVAC Fan Schedule (On/Off)			External Lighting Schedule	Basement Ventilation	Basement Lighting
	Retail	Corridors & Atrium	Special Zones			
	7 Days/ week	7 Days/ week	7 Days/ week			
00:00-01:00	0	0	0	1.00	1.00	1.00
01:00-02:00	0	0	0	0.50	0.00	0.05
02:00-03:00	0	0	0	0.50	0.00	0.05
03:00-04:00	0	0	0	0.50	0.00	0.05
04:00-05:00	0	0	0	0.50	0.00	0.05
05:00-06:00	0	0	0	0.50	0.00	0.05
06:00-07:00	0	0	0	0.00	0.00	0.05
07:00-08:00	0	0	0	0.00	0.00	0.05
08:00-09:00	0	0	0	0.00	0.00	0.05
09:00-10:00	0	1	1	0.00	1.00	1.00
10:00-11:00	1	1	1	0.00	1.00	1.00
11:00-12:00	1	1	1	0.00	1.00	1.00
12:00-13:00	1	1	1	0.00	1.00	1.00
13:00-14:00	1	1	1	0.00	1.00	1.00
14:00-15:00	1	1	1	0.00	1.00	1.00
15:00-16:00	1	1	1	0.00	1.00	1.00
16:00-17:00	1	1	1	0.00	1.00	1.00
17:00-18:00	1	1	1	0.00	1.00	1.00
18:00-19:00	1	1	1	1.00	1.00	1.00
19:00-20:00	1	1	1	1.00	1.00	1.00
20:00-21:00	1	1	1	1.00	1.00	1.00
21:00-22:00	0	1	1	1.00	1.00	1.00
22:00-23:00	0	1	1	1.00	1.00	1.00
23:00-24:00	0	1	1	1.00	1.00	1.00

Table 9-19 Schedules for Shopping Complex- Strip Retail & Supermall Buildings (A)

Strip Retail & Supermall						
Time Period	Occupancy Schedule		Lighting Schedule	Equipment Schedule	Elevator Schedule	
	Retail & Circulation		All Spaces	All Spaces		
	Weekdays	Weekends	7 Days/ week	7 Days/ week	Weekdays	Weekends
00:00-01:00	0.00	0.00	0.05	0.05	0.00	0.00
01:00-02:00	0.00	0.00	0.05	0.05	0.00	0.00
02:00-03:00	0.00	0.00	0.05	0.05	0.00	0.00
03:00-04:00	0.00	0.00	0.05	0.05	0.00	0.00
04:00-05:00	0.00	0.00	0.05	0.05	0.00	0.00
05:00-06:00	0.00	0.00	0.05	0.05	0.00	0.00
06:00-07:00	0.00	0.00	0.05	0.05	0.00	0.00
07:00-08:00	0.00	0.00	0.05	0.05	0.10	0.10
08:00-09:00	0.00	0.00	0.05	0.05	0.10	0.10
09:00-10:00	0.20	0.20	0.20	0.05	0.20	0.20
10:00-11:00	0.40	0.40	0.50	0.90	0.40	0.40
11:00-12:00	0.60	0.60	0.95	0.90	0.70	0.70
12:00-13:00	0.60	0.70	0.95	0.90	0.70	0.80
13:00-14:00	0.60	0.90	0.95	0.90	0.70	0.95
14:00-15:00	0.70	0.90	0.95	0.90	0.70	0.95
15:00-16:00	0.70	0.90	0.95	0.90	0.70	0.95
16:00-17:00	0.70	0.90	0.95	0.90	0.70	0.95
17:00-18:00	0.70	0.90	0.95	0.90	0.80	0.95
18:00-19:00	0.90	0.95	0.95	0.90	0.80	0.95
19:00-20:00	0.90	0.95	0.95	0.90	0.80	0.95
20:00-21:00	0.90	0.95	0.95	0.50	0.80	0.95
21:00-22:00	0.00	0.00	0.05	0.05	0.00	0.00
22:00-23:00	0.00	0.00	0.05	0.05	0.00	0.00
23:00-24:00	0.00	0.00	0.05	0.05	0.00	0.00

Table 9-20 Schedules for Shopping Complex- Strip Retail & Supermall Buildings (A)

Strip Retail & Supermall				
Time Period	HVAC Fan Schedule (On/Off)	External Lighting Schedule	Basement Ventilation	Basement Lighting
	7 Days/ week	7 Days/ week	7 Days/ week	7 Days/ week
00:00-01:00	0	0.20	0.00	0.05
01:00-02:00	0	0.20	0.00	0.05
02:00-03:00	0	0.20	0.00	0.05
03:00-04:00	0	0.20	0.00	0.05
04:00-05:00	0	0.20	0.00	0.05
05:00-06:00	0	0.20	0.00	0.05
06:00-07:00	0	0.00	0.00	0.05
07:00-08:00	0	0.00	0.00	0.05
08:00-09:00	0	0.00	0.00	0.05
09:00-10:00	1	0.00	1.00	1.00
10:00-11:00	1	0.00	1.00	1.00
11:00-12:00	1	0.00	1.00	1.00
12:00-13:00	1	0.00	1.00	1.00
13:00-14:00	1	0.00	1.00	1.00
14:00-15:00	1	0.00	1.00	1.00
15:00-16:00	1	0.00	1.00	1.00
16:00-17:00	1	0.00	1.00	1.00
17:00-18:00	1	0.00	1.00	1.00
18:00-19:00	1	1.00	1.00	1.00
19:00-20:00	1	1.00	1.00	1.00
20:00-21:00	1	1.00	1.00	1.00
21:00-22:00	0	1.00	0.20	0.50
22:00-23:00	0	0.20	0.00	0.05
23:00-24:00	0	0.20	0.00	0.05

Table 9-21 Schedules for Assembly Buildings

Assembly								
Time Period	Occupancy Schedule	Lighting Schedule	Equipment Schedule	Elevator Schedule	HVAC Fan Schedule (On/Off)	External Lighting Schedule	Basement Ventilation	Basement Lighting
00:00-01:00	0.00	0.00	0.00	0.00	0	0.80	0.00	0.80
01:00-02:00	0.00	0.00	0.00	0.00	0	0.80	0.00	0.10
02:00-03:00	0.00	0.00	0.00	0.00	0	0.80	0.00	0.10
03:00-04:00	0.00	0.00	0.00	0.00	0	0.80	0.00	0.10
04:00-05:00	0.00	0.00	0.00	0.00	0	0.80	0.00	0.10
05:00-06:00	0.00	0.00	0.00	0.00	0	0.80	0.00	0.10
06:00-07:00	0.00	0.00	0.00	0.00	0	0.00	0.00	0.10
07:00-08:00	0.00	0.00	0.00	0.00	0	0.00	0.00	0.10
08:00-09:00	0.20	0.40	0.30	0.20	0	0.00	1.00	0.80
09:00-10:00	0.20	0.75	0.50	0.50	1	0.00	1.00	0.80
10:00-11:00	0.20	0.95	0.95	0.50	1	0.00	1.00	0.80
11:00-12:00	0.80	0.95	0.95	0.50	1	0.00	1.00	0.80
12:00-13:00	0.80	0.95	0.95	0.50	1	0.00	1.00	0.80
13:00-14:00	0.80	0.95	0.95	0.50	1	0.00	1.00	0.80
14:00-15:00	0.80	0.95	0.95	0.50	1	0.00	1.00	0.80
15:00-16:00	0.80	0.95	0.95	0.50	1	0.00	1.00	0.80
16:00-17:00	0.80	0.95	0.95	0.50	1	0.00	1.00	0.80
17:00-18:00	0.80	0.95	0.95	0.50	1	0.00	1.00	0.80
18:00-19:00	0.50	0.95	0.50	0.50	1	0.80	1.00	0.80
19:00-20:00	0.20	0.40	0.30	0.40	1	0.80	1.00	0.80
20:00-21:00	0.20	0.40	0.30	0.20	0	0.80	1.00	0.80
21:00-22:00	0.20	0.40	0.30	0.20	0	0.80	1.00	0.80
22:00-23:00	0.10	0.10	0.00	0.00	0	0.80	1.00	0.80
23:00-24:00	0.10	0.10	0.00	0.00	0	0.80	0.00	0.80

Table 9-22 Schedules for Business - Office Buildings

Business - Office							
Time Period	HVAC Fan Schedule (On/Off)		External Lighting Schedule	Basement Ventilation		Basement Lighting	
	Daytime Business	24 Hour Business	7 Days/ week	Daytime Business	24 Hour Business	Daytime Business	24 Hour Business
00:00-01:00	0	1	0.80	0.00	1.00	0.05	1.00
01:00-02:00	0	1	0.80	0.00	1.00	0.05	1.00
02:00-03:00	0	1	0.80	0.00	1.00	0.05	1.00
03:00-04:00	0	1	0.80	0.00	1.00	0.05	1.00
04:00-05:00	0	1	0.80	0.00	1.00	0.05	1.00
05:00-06:00	0	1	0.80	0.00	1.00	0.05	1.00
06:00-07:00	0	1	0.00	0.00	1.00	0.05	1.00
07:00-08:00	1	1	0.00	0.00	1.00	0.05	1.00
08:00-09:00	1	1	0.00	1.00	1.00	1.00	1.00
09:00-10:00	1	1	0.00	1.00	1.00	1.00	1.00
10:00-11:00	1	1	0.00	1.00	1.00	1.00	1.00
11:00-12:00	1	1	0.00	1.00	1.00	1.00	1.00
12:00-13:00	1	1	0.00	1.00	1.00	1.00	1.00
13:00-14:00	1	1	0.00	1.00	1.00	1.00	1.00
14:00-15:00	1	1	0.00	1.00	1.00	1.00	1.00
15:00-16:00	1	1	0.00	1.00	1.00	1.00	1.00
16:00-17:00	1	1	0.00	1.00	1.00	1.00	1.00
17:00-18:00	1	1	0.00	1.00	1.00	1.00	1.00
18:00-19:00	1	1	0.80	1.00	1.00	1.00	1.00
19:00-20:00	1	1	0.80	1.00	1.00	1.00	1.00
20:00-21:00	1	1	0.80	1.00	1.00	1.00	1.00
21:00-22:00	1	1	0.80	0.00	1.00	0.05	1.00
22:00-23:00	0	1	0.80	0.00	1.00	0.05	1.00
23:00-24:00	0	1	0.80	0.00	1.00	0.05	1.00

Appendices

10. Appendix A: Default Values for Typical Constructions

10.1 Procedure for Determining Fenestration Product U-factor and Solar Heat Gain Coefficient

§ 4.2.1.1 and § 4.2.1.2 require that U-factors and solar heat gain coefficients (SHGC) be determined for the overall fenestration product (including the sash and frame) in accordance with ISO 15099. The building envelope trade-off option in § 4.3.5 requires the use of visible light transmittance (VLT).

In several cases, ISO 15099 suggests that individual national standards will need to be more specific and in other cases the ISO document gives users the choice of two options. This section clarifies these specific issues as they are to be implemented for this code:

- (a) § 4.1 of ISO 15099: For calculating the overall U-factor, ISO 15099 offers a choice between the linear thermal transmittance (4.1.2) and the area weighted method (4.1.3). The area weighted method (4.1.3) shall be used.
- (b) § 4.2.2 of ISO 15099: Frame and divider SHGC's shall be calculated in accordance with § 4.2.2. The alternate approach in § 8.6 shall not be used.
- (c) § 6.4 of ISO 15099 refers the issue of material properties to national standards. Material conductivities and emissivity shall be determined in accordance with Indian standards.
- (d) § 7 of ISO 15099 on shading systems is currently excluded.
- (e) § 8.2 of ISO 15099 addresses environmental conditions. The following are defined for India:

For U-factor calculations:

$$T_{in} = 24 \text{ }^{\circ}\text{C}$$

$$T_{out} = 32 \text{ }^{\circ}\text{C}$$

$$V = 3.35 \text{ m/s}$$

$$T_{rm,out} = T_{out}$$

$$T_{rm,in} = T_{in}$$

$$I_s = 0 \text{ W/m}^2$$

For SHGC calculations:

$$T_{in} = 24 \text{ }^{\circ}\text{C}$$

$$T_{out} = 32 \text{ }^{\circ}\text{C}$$

$$V = 2.75 \text{ m/s}$$

$$T_{rm,out} = T_{out}$$

$$T_{rm,in} = T_{in}$$

$$I_s=783 \text{ W/m}^2$$

- (f) § 8.3 of ISO 15099 addresses convective film coefficients on the interior and exterior of the window product. In § 8.3.1 of ISO 15099, simulations shall use the heat transfer coefficient based on the center of glass temperature and the entire window height; this film coefficient shall be used on all indoor surfaces, including frame sections. In § 8.3.2 of ISO 15099, the formula from this section shall be applied to all outdoor exposed surfaces.
- (g) § 8.4.2 of ISO 15099 presents two possible approaches for incorporating the impacts of self-viewing surfaces on interior radiative heat transfer calculations. Products shall use the method in § 8.4.2.1 of ISO 15099 (Two-Dimensional Element to Element View Factor Based Radiation Heat Transfer Calculation). The alternate approach in § 8.4.3 of ISO 15099 shall not be used.

10.2 Default U-factors and Solar Heat Gain Coefficients for Unrated Fenestration Products

All fenestration with U-factors, SHGC, or visible light transmittance determined, certified, and labeled in accordance ISO 15099 shall be assigned those values.

10.2.1 Unrated Vertical Fenestration.

Unlabeled vertical fenestration, both operable and fixed, shall be assigned the U-factors, SHGCs, and visible light transmittances in Table 10.2.1.

Table 10-1 Defaults for Unrated Vertical Fenestration (Overall Assembly including the Sash and Frame)

Frame Type	Glazing Type	U-Factor (W/m ² .K)
All frame types	Single Glazing	7.1
Wood, vinyl, or fiberglass frame or metal frame with thermal break	Double Glazing	3.4
Metal and other frame type	Double Glazing	5.1

10.2.2 Unrated Sloped Glazing and Skylights

Unrated sloped glazing and skylights, both operable and fixed, shall be assigned the SHGCs and visible light transmittances in Table 10-1. To determine the default U-factor for unrated sloped glazing and skylights without a curb, multiply the values in Table 10-1 by 1.2. To determine the default U-factor for unrated skylights on a curb, multiply the values in Table 10-1 by 1.6.

10.3 Typical Roof Constructions

For calculating the overall U-factor of a typical roof construction, the U-factors from the typical wall construction type and effective U-factor for insulation shall be combined according to the following equation:

$$U_{TotalRoof} = \frac{1}{\frac{1}{U_{TypicalRoof}} + \frac{1}{U_{TypicalInsulation}}}$$

where

$U_{TotalRoof}$ Total U-factor of the roof with insulation

$U_{Typical Roof}$ U-factor of the roof

$U_{Typical Insulation}$ U-factor of the effective insulation

10.4 Typical Wall Constructions

For calculating the overall U-factor of a typical wall construction, the U-factors from the typical wall construction type and effective U-factor for insulation shall be combined according to the following equation:

$$U_{TotalWall} = \frac{1}{\frac{1}{U_{TypicalWall}} + \frac{1}{U_{TypicalInsulation}}}$$

where

$U_{TotalWall}$ Total U-factor of the wall with insulation

$U_{Typical Wall}$ U-factor of the wall

$U_{Typical Insulation}$ U-factor of the effective insulation

Table 10-2 Typical Thermal Properties of Common Building and Insulating Materials²

Name	Form	Density kg/m ³	Thermal Conductivity W/(mK)	Specific Heat MJ/m ³ K
Acrylic Sheet	Board	1145	0.2174	1.5839
Armor	Insulation	270	0.0678	0.1578
Asbestos Cement Board	Board	1404	0.4709	0.7218
Asbestos Sheet -Sera	Board	1377	0.5128	1.2043
Autoclaved Aerated Concrete Block (AAC)	Block	642	0.1839	0.794
Bamboo	Wood	913	0.1959	0.6351
Brass	Metal	8500	106.48	11.1164
Calcium Silicate Board	Board	1016	0.281	0.8637
Composite Marble	Stone	3146	2.44	2.1398
Cement Board	Board	1340	0.4384	0.8113
Cement Bonded Particle Board	Board	1251	0.3275	1.1948
Ceramic Fiber Blanket	Insulation	128	0.0491	0.1093
Cement Fiber Board	Board	1276	0.388	0.8973
Cement Plaster		278	1.208	0.9719
Cement Powder	Powder	1070	0.1137	0.7943
Ceramic Blue Tile	Tile	2707	1.372	1.2082
Ceramic Frit Glass	Glass	2520	0.6882	0.7859
Ceramic Tile - Bathroom	Tile	2549	0.8018	1.6168
Ceramic Tile	Tile	2700	1.5996	1.1438
Chile Wood	Wood	362	0.1422	0.4102
Chitodio	Stone	3209	3.7512	2.1223
Clay Tile	Tile	2531	0.6323	1.4253

² Thermo-Physical-Optical Property Database of Construction Materials, U.S.- India Joint Center for Building Energy Research and Development (CBERD) and Ministry of New and Renewable Energy (MNRE).

³ This is not an all-inclusive list. The database of thermal properties of building materials is available at BEE website (<https://www.beeindia.gov.in/>).

Name	Form	Density kg/m ³	Thermal Conductivity W/(mK)	Specific Heat MJ/m ³ K
Float Glass/ Clear Glass	Glass	2477	1.0522	1.9654
Concrete Block 25/50	Block	2427	1.3957	0.4751
Concrete Block 30/60	Block	2349	1.4107	0.7013
Corian	Board	1750	1.012	2.0921
Crystal White Tile	Tile	2390	1.5094	1.9427
Dholpuri Stone	Stone	2262	3.084	1.583
Mineralized Water	Water	1000	0.6134	3.8165
Engineered Wood Floor Tiles	Tile	571	0.2527	1.423
Extruded Polystyrene XPS	Insulation	30	0.0321	0.0374
Fiber Reinforced Plastic (FRP)	Board	1183	0.2252	1.693
Fire Brick	Brick	2049	1.2729	1.2887
Floor Board	Board	954	0.2654	1.1423
Foam Cement Block	Block	581	0.1588	0.5359
Ghana Teak Wood	Wood	529	0.2062	0.5769
Glasswool	Insulation	49	0.0351	0.0339
Black Fine Granite	Stone	3535	2.4351	2.2511
Black Coarse Granite	Stone	3473	2.5433	2.1996
Green Marble	Stone	2650	2.372	2.5275
Green Rockwool	Insulation	96	0.045	0.1089
Gypsum Board	Board	623	0.2527	0.6033
Gypsum Powder	Powder	588	0.202	1.1918
Gypsum Powder from Board	Powder	542	0.1033	0.626
Italian Black Granite	Stone	2911	2.3636	2.2349
Italian Marble	Stone	2630	2.7752	2.1869
Jaisalmer Yellow Stone	Stone	3006	2.7447	2.0954

Name	Form	Density kg/m ³	Thermal Conductivity W/(mK)	Specific Heat MJ/m ³ K
Jalore	Stone	2982	3.4412	1.9617
Kota Stone	Stone	3102	3.0229	2.0732
Laminated Particle Board	Board	656	0.1841	1.2621
Lime Powder	Powder	607	0.1286	0.7078
Mangalore Roof Tile	Tile - Roof	2531	0.6051	1.2809
Ambaji Marble	Stone	3128	2.8108	2.1943
Medium Density Fiberboard (MDF)	Board	133	0.2045	0.961
Melamine Fiberboard	Board	807	0.2459	0.6509
Mild Steel (MS)	Metal	7823	44.117	4.1896
Mineral Fiber - Ceiling	Board	364	0.071	0.3222
Mineral Fiber - Plain	Board	773	0.2739	0.6427
Oak Laminated Floor Tiles	Tile	949	0.2652	1.3389
Concrete Paver Tiles	Tile	2210	1.7248	1.3413
Paver Tile	Tile	2612	1.4763	1.2737
Plain & Prelaminated Particle Board	Board	902	0.271	0.974
Plaster of Paris (POP) Powder	Powder	1000	0.1353	0.9526
Plywood	Board	697	0.221	0.7258
Polyisocyanurate (PIR)	Insulation	40	0.0364	0.0685
Polymer (Anisotropic)	Plastic	1743	0.5027	1.6968
Polyurethane Foam (PUF)	Insulation	40	0.0372	0.0704
POP Board	Board	1080	0.4994	1.2167
Porcelain Tile	Tile	2827	1.5331	1.6259
Pumice Square - Bronze Tile	Tile	2327	0.9907	0.4382
Quartz	Stone	2359	3.7603	1.8277
Rajnagar Marble	Stone	3332	5.6405	2.777

Name	Form	Density kg/m ³	Thermal Conductivity W/(mK)	Specific Heat MJ/m ³ K
Rigid Polyurethane (40 Kg/m ³)	Insulation	40	0.0269	0.0766
Rigid Polyurethane	Insulation	25	0.0384	0.0763
Rockwool	Insulation	64	0.0461	0.0904
Rubber - Foam	Insulation	89	0.0561	0.1486
Rubber Wood	Wood	472	0.1679	0.5034
Saag Wood	Wood	959	0.2886	1.0258
Sand	Powder	1600	0.3075	1.1343
Sandstone	Stone	2530	3.0097	1.5957
Serpentine Green Granite	Stone	3068	2.1363	2.4484
Soft Board	Board	274	0.0943	0.2753
Soft Board-High Density	Board	353	0.0983	0.2621
Stainless Steel (SS)	Metal	7950	13.5633	3.6351
Steam Beech Wood	Wood	241	0.2331	0.5512
Straw Board	Board	760	0.2237	0.7098
Teak Wood	Wood	665	0.2369	0.8412
Tempered Glass	Glass	2500	1.0493	1.9227
Tinted Glass	Glass	2500	1.0428	1.8904
Udaipur Brown Marble	Stone	3197	2.921	2.2184
V-Board	Board	1191	0.2977	0.8245
Veneered Particle Board	Board	788	0.2363	0.7075
Vitrified Tile	Tile	2719	1.4786	1.8049
Resource Efficient Bricks (REB)	Brick	1520	0.6314	0.9951
Wood	Wood	802	0.2652	0.8715
Wood Pattern Chitodio	Stone	3126	3.4258	2.2852

11. Appendix B: Climate Zone Map of India

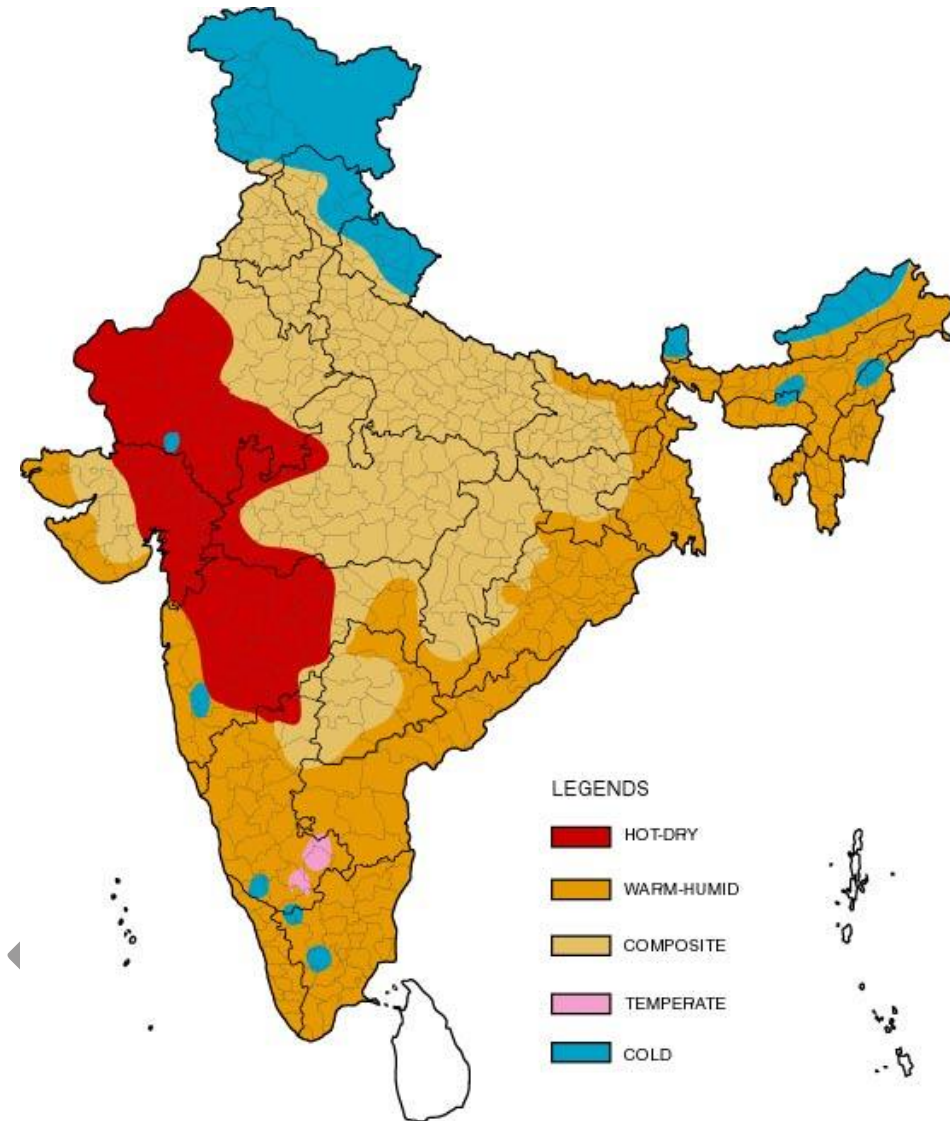

Table 11-1 Climate Zone for Major Indian Cities

City	Climate Type	City	Climate Type
Ahmedabad	Hot & Dry	Kurnool	Warm & Humid
Allahabad	Composite	Leh	Cold
Amritsar	Composite	Lucknow	Composite
Aurangabad	Hot & Dry	Ludhiana	Composite
Bangalore	Temperate	Chennai	Warm & Humid
Barmer	Hot & Dry	Manali	Cold
Belgaum	Warm & Humid	Mangalore	Warm & Humid
Bhagalpur	Warm & Humid	Mumbai	Warm & Humid
Bhopal	Composite	Nagpur	Composite
Bhubaneswar	Warm & Humid	Nellore	Warm & Humid
Bikaner	Hot & Dry	New Delhi	Composite
Chandigarh	Composite	Panjim	Warm & Humid
Chitradurga	Warm & Humid	Patna	Composite
Dehradun	Composite	Pune	Warm & Humid
Dibrugarh	Warm & Humid	Raipur	Composite
Guwahati	Warm & Humid	Rajkot	Composite
Gorakhpur	Composite	Ramgundam	Warm & Humid
Gwalior	Composite	Ranchi	Composite
Hissar	Composite	Ratnagiri	Warm & Humid
Hyderabad	Composite	Raxaul	Warm & Humid
Imphal	Warm & Humid	Saharanpur	Composite
Indore	Composite	Shillong	Cold
Jabalpur	Composite	Sholapur	Hot & Dry
Jagdelpur	Warm & Humid	Srinagar	Cold
Jaipur	Composite	Sundernagar	Cold
Jaisalmer	Hot & Dry	Surat	Hot & Dry
Jalandhar	Composite	Tezpur	Warm & Humid
Jamnagar	Warm & Humid	Tiruchirappalli	Warm & Humid
Jodhpur	Hot & Dry	Trivandrum	Warm & Humid
Jorhat	Warm & Humid	Tuticorin	Warm & Humid
Kochi	Warm & Humid	Udhagamandalam	Cold
Kolkata	Warm & Humid	Vadodara	Hot & Dry
Kota	Hot & Dry	Veraval	Warm & Humid
Kullu	Cold	Vishakhapatnam	Warm & Humid

12. Appendix C: Air-Side Economizer Acceptance Procedures

12.1 Construction Inspection

Prior to Performance Testing, verify and document the following:

- (a) System controls are wired correctly to ensure economizer is fully integrated (i.e. economizer will operate when mechanical cooling is enabled).
- (b) Economizer lockout control sensor location is adequate (open to air but not exposed to direct sunlight nor in an enclosure; away from sources of building exhaust; at least 8 meters away from cooling towers).
- (c) System is provided with barometric relief, relief fan or return fan to control building pressure.

12.2 Equipment Testing

Step 1: Simulate a cooling load and enable the economizer by adjusting the lockout control set point. Verify and document the following:

- (a) Economizer damper modulates opens to 100% outside air.
- (b) Return air damper modulates closed and is completely closed when economizer damper is 100% open.
- (c) Economizer damper is 100% open before mechanical cooling is enabled.
- (d) Relief fan or return fan (if applicable) is operating or barometric relief dampers freely swing open.

Step 2: Continue from Step 1 and disable the economizer by adjusting the lockout control set point. Verify and document the following:

- (a) Economizer damper closes to minimum ventilation position.
- (b) Return air damper opens to at or near 100%.
- (c) Relief fan (if applicable) shuts off or barometric relief dampers close. Return fan (if applicable) may still operate even when economizer is disabled.

13. Appendix D: Compliance Forms

BEE Copy - Not For Circulation

Envelope Summary

Energy Conservation Building Code 2017 Compliance Forms

Project Info	Project Address	Date
		For Building Department Use
	Project Built-up Area [m ²]	
	Project Above-grade Area [m ²]	
	Project Conditioned Area [m ²]	
	Applicant Name and Address	
	Project Climatic Zone	

Building Classification	<input type="checkbox"/> Hospitality	<input type="checkbox"/> Business
	<input type="checkbox"/> Health Care	<input type="checkbox"/> Educational
	<input type="checkbox"/> Assembly	<input type="checkbox"/> Shopping Complex

Project Description	<input type="checkbox"/> New Building	<input type="checkbox"/> Addition	<input type="checkbox"/> Alteration
	<input type="checkbox"/> Self-occupied	<input type="checkbox"/> Core and Shell	<input type="checkbox"/> Mixed-Use
Compliance is sought for Energy efficiency level	<input type="radio"/> ECBC Compliant	<input type="radio"/> ECBC+ Compliant	<input type="radio"/> SuperECBC Compliant
EPI Ratio			

Compliance Approach	Prescriptive Method	Whole Building Performance Method	Building Trade-off Method-Envelope Compliance
---------------------	---------------------	-----------------------------------	---

Building Envelope				
Vertical Fenestration Area Calculation	Total Vertical Fenestration Area (rough opening)	/	Gross Exterior Wall Area	X 100 = % Window to Wall Ratio (WWR)
				X 100 =
Skylight Area Calculation	Total Skylight Area (rough opening)	/	Gross Exterior Wall Area	times 100 equals % Skylight to roof ratio (SRR)
		÷		X 100 =

Opaque Assembly		
Wall (Minimum Insulation U-factor)		
Roof (Minimum Insulation U-factor)		
Cool Roof		
Solar Reflectance		
Emittance		
Wall Assembly		
Material	R-value	Assembly U-Factor

Daylighting Summary	
% above-grade floor area meeting the UDI requirement for 90% of the potential daylight time in a year	
Fenestration	
Vertical	
<i>Maximum U-factor</i>	
<i>Maximum SHGC (or SC)</i>	
<i>Minimum VLT</i>	
Overhang / Sidesfins / Box Frame Projection (yes or no)	
<i>If yes, enter Projection Factor for each orientation and effective SHGC</i>	
Skylight	
<i>Maximum U-factor</i>	
<i>Maximum SHGC (or SC)</i>	

BEE Copy - Not For Circulation

Envelope Checklist

Energy Conservation Building Code 2017 Compliance Forms

Project Address		Date	
-----------------	--	------	--

Applicability			Code Section	Component	Information Required	Location on Plans	Building Department Notes
Yes	No	N/A					
Mandatory Provisions (Section 4.2)							
			4.2.1	Fenestration rating			
			4.2.1.1	U-factor	Specify reference standard		
			4.2.1.2	SHGC	Specify reference standard		
			4.2.2	Opaque U-factors	Specify reference standard		
			4.2.3	Daylighting	Specify simulation approach or prescriptive		
			4.2.4	Building envelope sealing	Indicate sealing, caulking, gasketing, and weatherstripping		

Prescriptive Compliance Option (Section 4.3)							
			4.2.5	Roofs	Specify implemented U factor		
			4.2.6	Opaque External Wall	Specify implemented U factor		
			4.3.1	Vertical fenestration	(1) Indicate U-factors on fenestration schedule. Indicate if values are rated or default. If values are default, then specify frame type, glazing layers, gapwidth, low-e. (2) Indicate SHGC or SC on fenestration schedule. Indicate if values are rated or default. (3) Indicate VLT of fenestration schedule. Indicate if values are rated or default. (4) Indicate if overhangs or side fins or box-frame projection are used for compliance purposes. If so, provide projection factor calculation and equivalent SHGC calculation		
			4.3.2	fenestration U factor exemption	Specify if applicable, specify unconditioned space percentage, and specify incorporated specifications		
			4.3.2	Skylights	(1) Indicate U-factors on fenestration schedule. Indicate if values are rated or default. If values are default, then specify frame type, glazing layers, gap width, low-e. (2) Indicate SHGC or SC on fenestration schedule. Indicate if values are rated or default.		
			4.3.3.1	Vegetative cool roof	Specify the solar reflectance, emittance, and reference standards		

Building Envelope Trade-Off Option (Section 4.3.4)							
					Provide calculations		

Comfort System and Control Summary

Energy Conservation Building Code 2017 Compliance Forms

Project Info	Project Address:	Date
	Project Built-up Area (sq.m):	For Building Department Use
	Project Above-grade area (sq.m):	
	Project Conditioned Area (sq.m):	
	Applicant Name and Address:	
	Project Climatic Zone:	

Project Description	
Briefly describe comfort system type and features.	Natural ventilation, mechanical Ventilation, Low energy comfort system, heating and cooling mechanical equipment. percentage area distribution for the installed system, and related information

Compliance Option	System efficiency	Prescriptive Method	Whole Building Performance Method
-------------------	-------------------	---------------------	-----------------------------------

Equipment Schedules	The following information is required to be incorporated with the mechanical equipment schedules on the plans. For projects without plans, fill in the required information below.
---------------------	--

Cooling Equipment Schedule								
Equip. ID	Brand Name	Model No.	Capacity kW	Testing Standards	OSA CFM or Economizer?	COP	IPLV	Location

Heating Equipment Schedule								
Equip. ID	Brand Name	Model No.	Capacity kW	Testing Standards	OSA CFM or Economizer?	Input kW	Output kW	Efficiency

Fan Equipment Schedule							
Equipment ID	Brand Name	Model No.	Testing Standards	SP	Efficiency	Flow Control	Location of Service

BEE Copy - Not For Circulation

Comfort System & Controls Checklist

Energy Conservation Building Code 2017 Compliance Forms

Project Address				Date			
The following information is necessary to check a building permit application for compliance with the mechanical requirements in the Energy Conservation Building Code.							
Applicability			Code Section	Component	Information Required	Location on Plans	Building Department Notes
Yes	No	N/A					
Comfort Systems and Control							
Mandatory Provisions (Section 5.2)							
			5.2.1	Ventilation	Indicate all habitable spaces are ventilated with outdoor air in accordance with § 5.2.1 and guidelines specified in NBC		
			5.2.2	Minimum Space Conditioning Equipment Efficiencies	Provide equipment schedule with type, capacity, efficiency		
			5.2.3	Controls			
			5.2.3.1	Timeclock	Indicate thermostat with night setback, 3 different day types per week, and 2-hour manual override, capable of retaining programming and time setting during loss of power for a period of at least 10 hours		
			5.2.3.2	Temperature Controls	Indicate temperature control with 3°C deadband minimum if the system provides both heating and cooling.		
					Indicate thermostats are interlocked to prevent simultaneous heating and cooling, where separate heating and cooling systems are there		
					Indicate separate thermostat control for space types mentioned in § 5.2.3.2.(c)		
			5.2.2.3	Occupancy Controls	Indicate occupancy controls for space types mentioned in § 5.2.3.3		
			5.2.2.4	Fan Controls	Indicate two-speed motor, pony motor, or variable speed drive to control the fans and controls shall be capable to reduce the fan speed to at least two third of installed fan power		
			5.2.2.5	Dampers	Indicate all air supply and exhaust equipment's having VFD shall have dampers that automatically close upon the situations mentioned in § 5.2.3.5		
			5.2.4	Additional Controls for ECBC+ Building			
			5.2.4.1	Centralized Demand Shed Controls	Indicate the building has a Building Management System, with all Mechanical cooling and heating systems having PLC to the zone level shall have the control capabilities mentioned in § 5.2.4.1		
			5.2.4.2	Supply Air temperature reset	Indicate multi zone mechanical cooling and heating systems shall have controls to automatically reset supply air temperature in response to building loads or outdoor air temperature by at least 25% of the difference between design supply air temperature and the design room air temperature.		
			5.2.4.3	Chilled Water Temperature	Indicate chilled water systems exceeding 350 kW shall have controls to automatically reset supply water temperatures by representative building loads or by outdoor air temperature		

		5.2.5	Additional controls for SuperECBC Building	Indicate that the mechanical systems comply with § 5.2.4 and § 5.2.5	
		5.2.5.1	Variable Air Volume Fan Control	Indicate Fans in VAV systems shall have controls or devices to limit fan motor demand as per § 5.2.5.1	
		5.2.6	Piping & ductwork	Indicate sealing, caulking, gasketing, and weatherstripping	
		5.2.6.1	Piping insulation	Indicate R-value of insulation	
		5.2.6.2	Ductwork and Plenum insulation	Indicate R-value of insulation	
		5.2.7	System Balancing	Show written balance report for HVAC systems serving zones with a total conditioned area exceeding 500 m2	
		5.2.8	Condensers	Indicate location of condenser and source of water used for condenser	
		5.2.9	Service Hot Water Heating		
		5.2.9.1	Solar Water Heating	Indicate all Hotels and hospitals have solar water heating equipment installed for hot water design capacity as per § 5.2.9.1	
		5.2.9.2	Heating Equipment Efficiency	Indicate service water heating equipment shall meet the performance and efficiency as per § 5.2.9.2	
		5.2.9.3	Supplementary Water Heating System	Indicate supplementary heating system is designed in consideration with § 5.2.9.3	
		5.2.9.4	Piping Insulation	Indicate the Piping insulation is compliant with § 5.2.6.1.	
		5.2.9.5	Heat Traps	Indicate vertical pipe risers serving water heaters and storage tanks are as per § 5.2.9.5	
		5.2.9.6	Swimming Pools	Indicate the heated pools are provided with a vapor retardent pool cover on the water surface and temperature control and minimum insulation value as per § 5.2.9.6	

Prescriptive Compliance Option (Section 5.3)

		5.3.1	Fans	Indicate fan type, motor efficiency and mechanical efficiency	
		5.3.2	Pumps	Indicate pump type (Primary, secondary, and condenser), its total installed capacity and efficiency	
		5.3.3	Cooling Towers	Indicate cooling tower type and installed capacity	
		5.3.4	Air-Economizer (ECBC/ECBC+/SuperECBC)	Indicate air economizer is capable of modulating outside-air and return-air dampers to supply 50% of design supply air quantity as outside-air for respective building type.	
		5.3.4	Water-economizer (ECBC/ECBC+/SuperECBC)	Indicate water economizer is capable of providing 50% of the expected system cooling load at outside air temperatures of 10°C dry-bulb/7.2°C wet-bulb and below, if the designed building is a respective building type.	
		5.3.4.3	Partial Cooling	Indicate where required by § 5.3.4 economizers shall be capable of providing partial cooling even when additional mechanical cooling is required to meet the cooling load.	
		5.3.4.4	Controls	Indicate air economizers are equipped with controls as specified in § 5.3.4.4	
		5.3.9	Testing	Indicate air-side economizers have been tested as per the requirement specified	

		5.3.5	Variable Flow Hydronic Systems			
		5.3.5.1	Variable Fluid Flow	Indicate design flow rate of HVAC pumping system		
		5.3.5.2	Isolation Valves	Indicate water cooled air-conditioning have two-way automatic isolation valves and pump motors greater than or equal to 3.7 kW is controlled by variable speed drives		
		5.3.5.3	Variable Speed Drives	Indicate Chilled water or condenser water systems comply with either § 5.3.5.1 or § 5.3.5.2		
		5.3.5.4	Heat Recovery	Indicate for all Hospitality and Healthcare, heat recovery effectiveness, and efficiency of oil and gas fired boilers		
		5.4	System Efficiency-Alternate Compliance approach	Attach simulation report		
		5.5	Low Energy Comfort Systems	Indicate system type and list the exemption claimed		

Lighting and Controls Summary

Energy Conservation Building Code 2017 Compliance Forms

Project Info	Project Address:	Date
		For Building Department Use
	Project Built-up Area (m ²):	
	Project Above-grade area (m ²):	
	Project Conditioned Area (m ²):	
	Applicant Name and Address:	
Project Climatic Zone:		

Compliance Option	<input type="checkbox"/> Space by Space method	<input type="checkbox"/> Whole Building Method
-------------------	--	--

Maximum Allowed Lighting Power (Interior, Section 6.3.2 or 6.3.3)

Location (floor/room no.)	Occupancy Description	Allowed Watts per m ² **	Area in m ²	Allowed x Area
** Document all exceptions			Total Allowed Watts	

Proposed Lighting Power (Interior)

Location (floor/room no.)	Fixture Description	Number of Fixtures	Watts/ Fixture	Watts Proposed
Total Proposed Watts may not exceed Total Allowed Watts for Interior			Total Proposed Watts	

Maximum Allowed Lighting Wattage (Exterior, Section 6.3.5)

Location	Description	Allowed Watts per m ² or per lm	Area in m ² (or lm for perimeter)	Allowed Watts x m ² (or x lm)
Total Allowed Watts				

Proposed Lighting Wattage (Exterior)

Location	Fixture Description	Number of Fixtures	Watts/ Fixture	Watts Proposed
Total Proposed Watts may not exceed Total Allowed Watts for Exterior			Total Proposed Watts	

Lighting & Controls Checklist

Energy Conservation Building Code 2017 Compliance Forms

Project Address						Date	
The following information is necessary to check a building permit application for compliance with the lighting requirements in the Energy Conservation Building Code 2017.							
Applicability			Code Section	Component	Information Required	Location on Plans	Building Department Notes
Yes	No	N/A					
Lighting and Controls							
Mandatory Provisions (Section 6.2)							
			6.2.1	Lighting Controls			
			6.2.1.1	Automatic shutoff	Indicate automatic shutoff locations or occupancy sensors		
			6.2.1.2	Space control	Provide schedule with type, indicate locations		
			6.2.1.3	Daylit Zones	Provide manual or automatic control device schedule with type and features, indicate locations		
			6.2.1.4	Centralized Controls_ECBC+ and SuperECBC Buildings	Provide centralized control system schedule with type and features, indicate locations		
			6.2.1.5	Ext. lighting control	Indicate photosensor or astronomical time switch		
			6.2.1.6	Additional control	Provide schedule with type, indicate locations		
			6.2.3	Exit signs	Indicate wattage per face of Exit signs		
Prescriptive Interior Lighting Power Compliance Option (Section 6.3)							
			6.3	LPD compliance	Indicate whether project is complying with the Building Area Method (6.3.2) or the Space Function Method (6.3.3)		
			6.3.2	Building area method	Provide lighting schedule with wattage of lamp and ballast and number of fixtures. Document all exceptions.		
			6.3.2	Space function method	Provide lighting schedule with wattage of lamp and ballast and number of fixtures. Document all exceptions.		
			6.3.3	Luminaire wattage	Indicate the wattage of installed luminaires on the floor plan. In case of luminaires containing permanently installed ballasts, the operating input wattage has to be provided, either from manufacturers catalogs or values from independent testing laboratory reports.		
Prescriptive Exterior Lighting Power Compliance Option (Section 6.3.5)							
			6.4	External light allowance	Provide lighting schedule with wattage of lamp and ballast and number of fixtures. Document all exceptions.		

Lighting & Controls Checklist

Energy Conservation Building Code 2017 Compliance Forms

Project Address					Date			
The following information is necessary to check a building permit application for compliance with the lighting requirements in the Energy Conservation Building Code 2017.								
Yes	No	N/A	Applicability	Code	Component	Information Required	Location on Plans	Building Department Notes
			Section					
Lighting and Controls								
Mandatory Provisions (Section 6.2)								
			6.2.1	Lighting Controls				
			6.2.1.1	Automatic shutoff	Indicate automatic shutoff locations or occupancy sensors			
			6.2.1.2	Space control	Provide schedule with type, indicate locations			
			6.2.1.3	Daylit Zones	Provide manual or automatic control device schedule with type and features, indicate locations			
			6.2.1.4	Centralized Controls_ECBC+ and SuperECBC Buildings	Provide centralized control system schedule with type and features, indicate locations			
			6.2.1.5	Ext. lighting control	Indicate photosensor or astronomical time switch			
			6.2.1.6	Additional control	Provide schedule with type, indicate locations			
			6.2.3	Exit signs	Indicate wattage per face of Exit signs			
Prescriptive Interior Lighting Power Compliance Option (Section 6.3)								
			6.3	LPD compliance	Indicate whether project is complying with the Building Area Method (6.3.2) or the Space Function Method (6.3.3)			
			6.3.2	Building area method	Provide lighting schedule with wattage of lamp and ballast and number of fixtures. Document all exceptions.			
			6.3.2	Space function method	Provide lighting schedule with wattage of lamp and ballast and number of fixtures. Document all exceptions.			
			6.3.3	Luminaire wattage	Indicate the wattage of installed luminaires on the floor plan. In case of luminaires containing permanently installed ballasts, the operating input wattage has to be provided, either from manufacturers catalogs or values from independent testing laboratory reports.			
Prescriptive Exterior Lighting Power Compliance Option (Section 6.3.5)								
			6.4	External light allowance	Provide lighting schedule with wattage of lamp and ballast and number of fixtures. Document all exceptions.			

14. Appendix E: BEE approved list of software to show compliance⁴

Table 14-1 Bureau of Energy Efficiency Approved Software for Demonstrating Compliance with ECBC

Analysis	Software
Whole Building Performance Method	AECOSim
	Design Builder
	DOE2
	EnergyPlus
	eQUEST
	HAP
	IDA-ICE
	IES-VE
	OpenStudio
	Simergy
	Trace700
	TRNSYS
	Visual DOE
Daylighting	AGI32 (Licaso)
	Daysim
	Design Builder
	DIVA
	Groundhog
	IES-VE
	OpenStudio
	RadianceRhino-Grasshopper with Daylighting Plugins
	Sefaira
	Sensor Placement + Optimization Tool (SPOT)

⁴ This is not an all-inclusive list. The current list of approved software is available at BEE website (<https://www.beeindia.gov.in/>).